

Motorized folding machine MFG 2515

Model	MFG 2515
Brand	<u>ERBEND</u>
Condition	new
Bending length	2550 mm
Sheet thickness (420 N/mm ²)	1.5 mm
Origin	Türkiye

⌚ approx. 10 weeks from order

€ 35.000,00

Leasing*: € 668,50

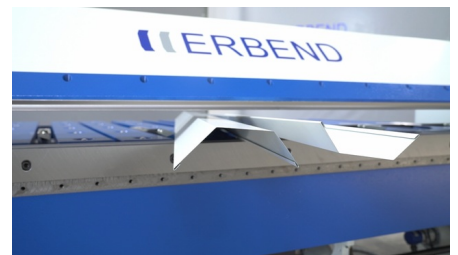
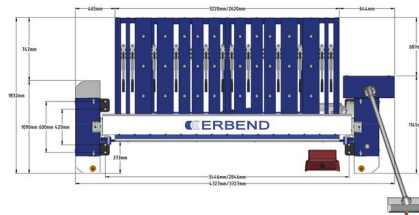

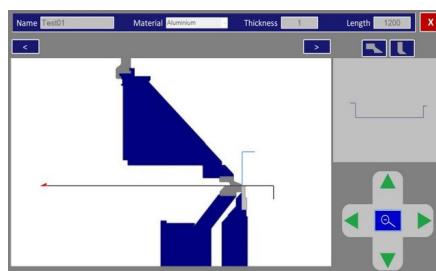
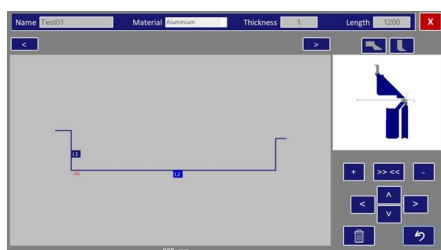
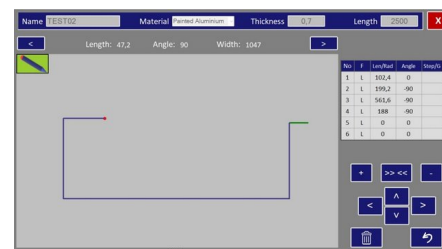
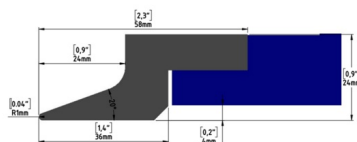
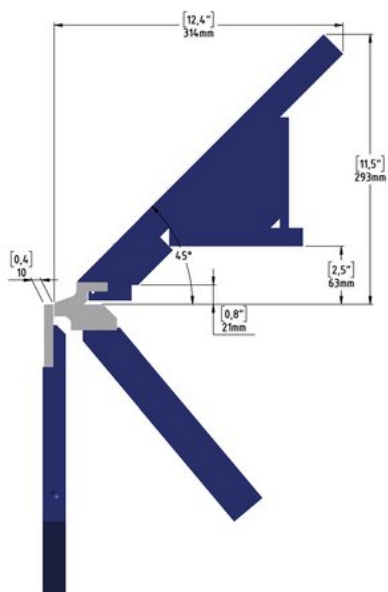

General characteristics

Bending length	2550 mm
Sheet thickness (420 N/mm ²)	1.5 mm
Max. thickness - stainless steel	1 mm
Max. thickness - aluminium	2 mm
Antrieb	Motorized
Max. bending angle	155 °
Max. opening	110 mm
Back gauge	750 mm
Back gauge speed	300 mm/s
Back gauge accuracy	0.1 +/- mm
adjustment range of the bending flange max.	0-20 mm
Bending speed	100 °/sek
Max. clamping speed	90 mm/s

Dimensions and weight

Length	3800 mm
Width	2100 mm
Height	1650 mm

Weight 2500 kg

Description

CNC control with tabular programming

- 15,6" touchscreen controller on swivel arm
- tabular programming by entering the axes values
- open or drop hemming function
- multi radius bending function as by pressing or by bending
- programming of material quality, thickness, spring back, bending correction and creating a data base for every type of material, thickness and length
- piece counter
- autorisation with password
- 128GB HDD allows almost unlimited data storage
- remote service connection via WLAN
- detailed alarm, tool and paramter page

back gauge 750 mm with servo drive, pull back sliders to create space for down flanges at the back of the bottom tool, ball casters

upper tool in one pice, 20°

manual height adjustment of bending beam

foot pedal with 3 switches

light barrier on the front side

Option:

back gauge 1000 mm € 2.870,-

Further information

Brochures

- [erbend-katalog-2026.pdf](#)

Product video

- [Motorische CNC Schwenkbiegemaschine ERBEND MFG Series](#)

Notice

Prices ex location, excluding VAT.

The General Terms and Conditions of Delivery of the Austrian Association of the Machine and Steel Construction Industry apply.

We only sell under retention of title, the goods remain our unrestricted property until they have been paid for in full.

Price changes and errors excepted.

* Monthly net leasing rate, leasing period 60 months, no down payment, 5% residual value, subject to a positive credit check. The leasing conditions of GRENKELEASING GmbH apply. Valid for lessees based in Austria.