

Export Pricelist

Preise in der Liste gelten netto ab Lieferwerk Italien.

Bitte die genauen Transportkosten anfragen unter

+43/2236/638 70-16 bzw. e-Mail stroh@hesse-maschinen.com

2023.01

Protezioni per
Macchine Utensili

Repar2
MACHINE GUARDS



Safety Guards
for Machine Tools



www.repar2.com



Repar2
MACHINE GUARDS



+393386795584

Repar2
MACHINE GUARDS

www.repar2.com

INDICE - INDEX - TABLE DES MATIÈRES - VERZEICHNIS - ÍNDICE

	PAG .
PROTEZIONI PER TORNI SAFETY GUARDS FOR TURNING MACHINES PROTECTEURS POUR TOURS SICHERHEITSVORRICHTUNGEN FÜR DREHBÄNKE PROTECCIONES PARA TORNOS	1-8
PROTEZIONI PER FRESATRICI SAFETY GUARDS FOR MILLING MACHINES PROTECTEURS POUR FRAISEUSES SICHERHEITSVORRICHTUNGEN FÜR FRÄSMASCHINEN PROTECCIONES PARA FRESADORAS	9-14
PROTEZIONI PER TRAPANI SAFETY GUARDS FOR DRILLING MACHINES PROTECTEURS POUR PERCEUSES SICHERHEITSVORRICHTUNGEN FÜR BOHRMASCHINEN PROTECCIONES PARA TALADRADORAS	15-18
PROTEZIONI PER RETTIFICHE UNIVERSALI E TANGENZIALI SAFETY GUARDS FOR SURFACE GRINDERS PROTECTEURS POUR RECTIFIEUSES DE SURFACES UNFALLSCHUTZVORRICHTUNG FÜR FLÄCHENSCHLEIFMASCHINEN PROTECCIONES PARA RECTIFICADORAS UNIVERSALES Y TANGENCIALES	19
PROTEZIONI PER SEGHELTO SAFETY GUARDS FOR SAWING MACHINES PROTECTEURS POUR SCIEUSES SICHERHEITSVORRICHTUNGEN FÜR SÄGEMASCHINEN PROTECCIONES PARA SIERRAS	20
PROTEZIONI PER ALESATRICI SAFETY GUARDS FOR BORING MACHINES PROTECTEURS POUR ALESEUSES SICHERHEITSVORRICHTUNGEN FÜR BOHRMASCHINEN PROTECCIONES PARA MANDRINADORAS	20
PROTEZIONI PER MOLATRICI SAFETY GUARDS FOR GRINDERS PROTECTEURS POUR MEULEUSES SICHERHEITSVORRICHTUNGEN FÜR SCHMIRGELGERÄTE PROTECCIONES PARA AFILADORAS	20
APPLICAZIONI UNIVERSALI - TOP LINE UNIVERSAL APPLICATIONS - TOP LINE APPLICATIONS UNIVERSELLES - TOP LINE UNIVERSELL EINSETZBAR - TOP LINE APPLICACIONES UNIVERSALES - TOP LINE	21
PROTEZIONI PER PRESSE SAFETY GUARDS FOR PRESSES PROTECTEURS POUR PRESSES SICHERHEITSVORRICHTUNGEN FÜR PRESSEN PROTECCIONES PARA PRENSAS	21
PROTEZIONI PER STOZZATRICI SAFETY GUARDS FOR SLOTTING MACHINES PROTECTEURS POUR MORTAISEUSES SICHERHEITSVORRICHTUNGEN FÜR STORMASCHINEN PROTECCIONES PARA RANURADORAS	22
ACCESSORI ACCESSORIES ACCESSOIRES ZUBEHÖR ACCESORIOS	22-23
PEDANE ANTISCIVOLO ANTISKIDDING FOOT-BOARDS PASSERELLE ANTIDERAPANTE RUTSCHSICHERE LAUFSTEGE PASARELAS ANTIRRESBALADIZAS	24
SISTEMI DI PROTEZIONE E BARRIERE MODULARI DIVISORIE IN ACCIAIO PERIMETER GUARDINGS SYSTÈMES DE PROTECTEUR ET BARRIÈRES DE DIVISION MODULAIRES EN TÔLE D'ACIER SCHUTZWÄNDE AUS STAHLGITTER SISTEMAS DE PROTECCIÓN Y BARRERAS DE DIVISION MODULARES EN LAMINA DE ACERO	25-28
CASSETTE ELETTRICHE BASSA TENSIONE - MICROINTERUTTORI LOW VOLTAGE EMERGENCY BOXES - MICROSWITCHES BOITES BASSE TENSION - MICROINTERRUPTEURS NOT-AUS DRUCKTASTER 24V MIT GEHAUSE - MICROSCHALTER CAJAS DE BAJA TENSION - MICROINTERRUPTORES	29

1 TURNING MACHINES



RAL YELLOW 1007

Code	Description	Unit Price	
		with Micro	w/out Micro
1 LATHES	TF - standard screen width: 240 mm - micro with piston 14MIC001		
1TF200CMA3	Lathe Chuck guard w/micro Dia.200 x 240 mm width-A3 standard attachment*	€ 333,00	€ 273,00
1TF300CMA3	Lathe Chuck guard w/micro Dia.300 x 240 mm width A3-standard attachment*	€ 333,00	€ 273,00
1TF350CMA3	Lathe Chuck guard w/micro Dia.350 x 240 mm width A3-standard attachment*	€ 333,00	€ 273,00
1TF400CMA3	Lathe Chuck guard w/micro Dia.400 x 240 mm width A3-standard attachment*	€ 333,00	€ 273,00
1TF450CMA3	Lathe Chuck guard w/micro Dia.450 x 240 mm width A3-standard attachment*	€ 361,00	€ 301,00
1TF500CMA3	Lathe Chuck guard w/micro Dia.500 x 240 mm width A3-standard attachment*	€ 361,00	€ 301,00
1TF600CMA3	Lathe Chuck guard w/micro Dia.600 x 240 mm width A3-standard attachment*	€ 361,00	€ 301,00

*A1/A2/A4 attachments - option on request

Option: screen width 180mm (same price)

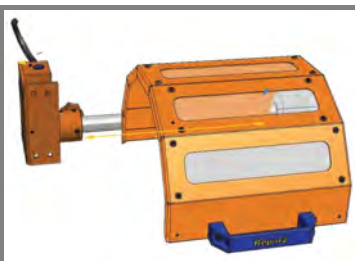

RAL YELLOW 1007

Code	Description	Unit Price	
		with Micro	w/out Micro
1 LATHES	TFPOL - standard poly windows width: 240mm - micro with piston 14MIC001		
1TFPOL200CMA3	Lathe Chuck guard w/micro Dia.200 A3-standard attachment*	€ 340,00	€ 280,00
1TFPOL300CMA3	Lathe Chuck guard w/micro Dia.300 A3-standard attachment*	€ 340,00	€ 280,00
1TFPOL350CMA3	Lathe Chuck guard w/micro Dia.350 A3-standard attachment*	€ 340,00	€ 280,00
1TFPOL400CMA3	Lathe Chuck guard w/micro Dia.400 A3-standard attachment*	€ 340,00	€ 280,00
1TFPOL450CMA3	Lathe Chuck guard w/micro Dia.450 A3-standard attachment*	€ 367,00	€ 307,00
1TFPOL500CMA3	Lathe Chuck guard w/micro Dia.500 A3-standard attachment*	€ 367,00	€ 307,00
1TFPOL600CMA3	Lathe Chuck guard w/micro Dia.600 A3-standard attachment*	€ 367,00	€ 307,00

*A1/A2/A4 attachments - option on request

Option: screen width 180mm (same price)

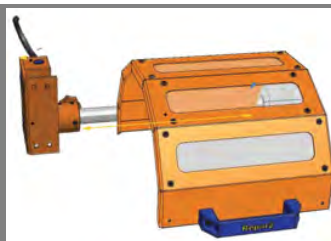

RAL YELLOW 1007

Code	Description	Unit Price	
		with Micro	w/out Micro
1 LATHES	TFVT - stand. glass windows width: 240mm - micro with piston 14MIC001		
1TFVT300CMA3	Lathe Chuck guard w/glass windows w/micro Dia.300 A3 standard attachment*	€ 454,00	€ 394,00
1TFVT350CMA3	Lathe Chuck guard w/glass windows w/micro Dia.350 A3 standard attachment*	€ 454,00	€ 394,00
1TFVT400CMA3	Lathe Chuck guard w/glass windows w/micro Dia.400 A3 standard attachment*	€ 454,00	€ 394,00
1TFVT450CMA3	Lathe Chuck guard w/glass windows w/micro Dia.450 A3 standard attachment*	€ 477,00	€ 417,00
1TFVT500CMA3	Lathe Chuck guard w/glass windows w/micro Dia.500 A3 standard attachment*	€ 477,00	€ 417,00
1TFVT600CMA3	Lathe Chuck guard w/glass windows w/micro Dia.600 A3 standard attachment*	€ 477,00	€ 417,00

*A1/A2/A4 attachments - option on request

Option: screen width 180mm (same price)

1 TURNING MACHINES



RAL YELLOW 1007

Code	Description	Unit Price	
		with Micro	w/out Micro
1 LATHES	TFM standard metal screen width: 240mm - micro with piston 14MIC001		
1TFM200CMA3	Lathe Chuck guard w/micro Dia.200 A3 standard attachment*	€ 480,00	€ 420,00
1TFM300CMA3	Lathe Chuck guard w/micro Dia.300 A3 standard attachment*	€ 480,00	€ 420,00
1TFM350CMA3	Lathe Chuck guard w/micro Dia.350 A3 standard attachment*	€ 480,00	€ 420,00
1TFM400CMA3	Lathe Chuck guard w/micro Dia.400 A3 standard attachment*	€ 480,00	€ 420,00
1TFM450CMA3	Lathe Chuck guard w/micro Dia.450 A3 standard attachment*	€ 503,00	€ 443,00
1TFM500CMA3	Lathe Chuck guard w/micro Dia.500 A3 standard attachment*	€ 503,00	€ 443,00
1TFM600CMA3	Lathe Chuck guard w/micro Dia.600 A3 standard attachment*	€ 503,00	€ 443,00

*A1/A2/A4 attachments - option on request

Option: screen width 180mm (same price)

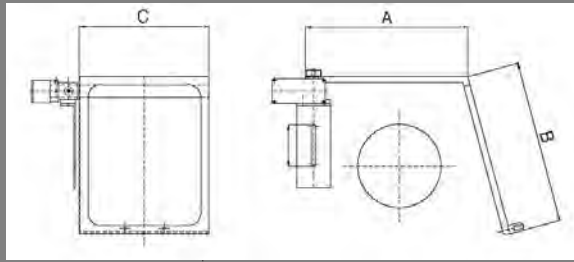

RAL YELLOW 1007

1 LATHES	IE - poly. or glass screen - micro with piston 14MIC001	with Micro w/out Micro	
		with Micro	w/out Micro
1IEAPCM	Lathe Chuck guard w/micro A=280 B=300 C=260 (polycarb.)	€ 346,00	€ 286,00
1IEAVCM	Lathe Chuck guard w/micro A=280 B=300 C=260 (glass)	€ 426,00	€ 366,00
1IEBPCM	Lathe Chuck guard w/micro A=390 B=390 C=310 (polycarb.)	€ 402,00	€ 342,00
1IEBVCM	Lathe Chuck guard w/micro A=390 B=390 C=310 (glass)	€ 482,00	€ 422,00
1IESPECM	Customized Lathe Chuck guard w/micro (polycarb.) - dimensions on request	€ 462,00	€ 402,00

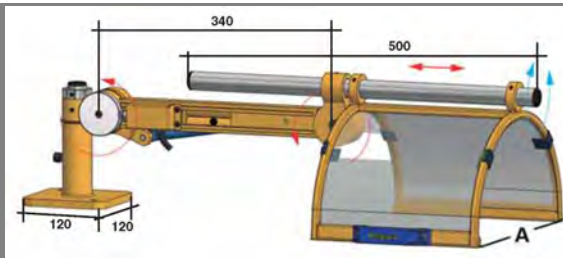

RAL YELLOW 1007

Model	PT / 300	PT / 350	PT / 400	PT / 450	PT / 500	PT / 600
Ø	300	350	400	450	500	600
LARG. mm	240					

1 LATHES	PT - poly screen width 240mm - Max. diam.600-micro with roller lever precabled 4MIC002	with Micro
1PT300CM	Lathe guard - arm equipped with gas spring and micro - Diam.300	€ 650,00
1PT350CM	Lathe guard - arm equipped with gas spring and micro - Dia.350	€ 650,00
1PT400CM	Lathe guard - arm equipped with gas spring and micro - Dia.400	€ 650,00
1PT450CM	Lathe guard - arm equipped with gas spring and micro - Dia.450	€ 680,00
1PT500CM	Lathe guard - arm equipped with gas spring and micro - Dia.500	€ 680,00
1PT600CM	Lathe guard - arm equipped with gas spring and micro - Dia.600 max.	€ 680,00

Option: screen width 180mm (same price)

1 TURNING MACHINES



extra: led LLS14

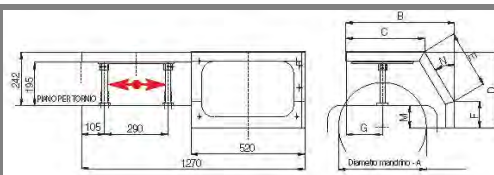

RAL YELLOW 1007

Mod. MINOR	A	B	C	D	E	F	G	M	N
AER	400	495	360	350	260	120	180	110	30°
SPECIAL	500	600	400	450	400	100	200	180	30°

Code	Description	Unit Price	
1 LATHES	MINOR- poly. or glass screens - micro with L-Type Key 14MIC004		
1MAERCM	Sliding guard for the lathe headstock w/micro	€ 930,00	€ 870,00
1MAERCMV	Sliding guard for the lathe headstock w/micro (glass screens)	€ 1.030,00	€ 970,00
1MSPECIALCM	Sliding guard for the lathe headstock w/micro	€ 1.002,00	€ 942,00
1MSPECIALCMV	Sliding guard for the lathe headstock w/micro (glass screens)	€ 1.102,00	€ 1.042,00
15LLS14	Extra charge for LED Light System - 10W	€ 290,00	



extra: led LLS7

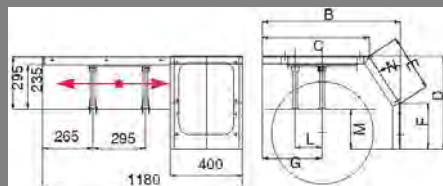

RAL YELLOW 1007

Mod. MAJOR	A	B	C	D	E	F	G	L	M	N
ST 700	600	765	590	505	345	210	335	150	210	30°
ST 800	700	870	670	560	390	220	390	150	265	30°
ST 1000	900	970	720	655	470	250	385	150	360	30°
ST 1200	1100	1125	830	780	560	280	430	150	465	30°
ST 1500	1400	1265	920	910	685	320	495	150	615	30°

1 LATHES	MAJOR -poly. or glass screens -micro with L-Type Key 14MIC004	with Micro	w/out Micro
1MJ700CM	Sliding guard for the lathe headstock w/micro Dia. 700	€ 1.023,00	€ 963,00
1MJ700CMV	Sliding guard for the lathe headstock (glass screens) Dia. 700	€ 1.123,00	€ 1.063,00
1MJ800CM	Sliding guard for the lathe headstock Dia. 800	€ 1.039,00	€ 979,00
1MJ800CMV	Sliding guard for the lathe headstock (glass screens) Dia. 800	€ 1.139,00	€ 1.079,00
1MJ1000CM	Sliding guard for the lathe headstock w/micro Dia. 1000	€ 1.092,00	€ 1.032,00
1MJ1000CMV	Sliding guard for the lathe headstock w/micro (glass screens) Dia. 1000	€ 1.192,00	€ 1.132,00
1MJ1200CM	Sliding guard for the lathe headstock w/micro Dia. 1200	€ 1.132,00	€ 1.072,00
1MJ1200CMV	Sliding guard for the lathe headstock w/micro (glass screens) Dia. 1200	€ 1.232,00	€ 1.172,00
1MJ1500CM	Sliding guard for the lathe headstock w/micro Dia. 1500	€ 1.209,00	€ 1.149,00
1MJ1500CMV	Sliding guard for the lathe headstock w/micro (glass screens) Dia. 1500	€ 1.309,00	€ 1.159,00
15LLS7	Extra charge for LED Light System - 5W	€ 225,00	

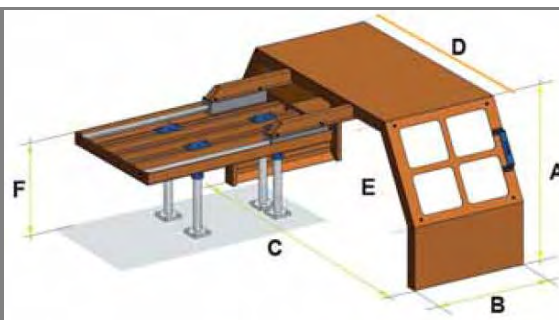

RAL YELLOW 1007

Code	Description	Unit Price	
1 LATHES	AM Customized guard-dimensions on request (poly.or glass screen) micro w/L-Type Key 14MIC004		
1AM....CM	Sliding guard for lathe chuck w/micro	price on request	

1 TURNING MACHINES



TGS01

TGS02

RAL YELLOW 1007

Code	Description	Unit Price
------	-------------	------------

1 LATHES **TGS01CM (1 screen) - TGS02 (2 screens) Vertical Lathes micro w/L-Type Key 14MIC004M**

price on request

Packing € 400,00 - extra charge for wooden cage



Cod. ART.	A	B	C	D	E	F	G
TP 700	600	800	883	410	430	472	432
TP 800	700	900	983	410	430	472	482
TP 1000	900	1100	1183	510	530	572	582
TP 1200	1100	1300	1383	610	630	672	682
TP 1500	1400	1600	1583	710	730	772	782

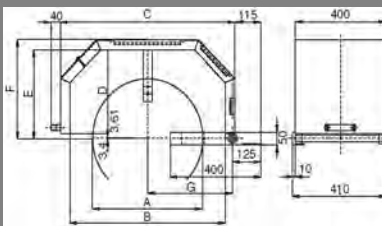

RAL YELLOW 1007

1 LATHES **TP metal screen -Big Lathes-micro with Roller Lever not precabled 14MIC003**

1TP700CM	Steel guard for the lathe chuck complete with double hinges and double micro Dia.700	€ 754,00
1TP800CM	Steel guard for the lathe chuck complete with double hinges and double micro Dia.800	€ 772,00
1TP1000CM	Steel guard for the lathe chuck complete with double hinges and double micro Dia.1000	€ 842,00
1TP1200CM	Steel guard for the lathe chuck complete with double hinges and double micro Dia.1200	€ 869,00
1TP1500CM	Steel guard for the lathe chuck complete with double hinges and double micro Dia.1500	€ 896,00

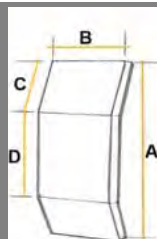

RAL YELLOW 1007

1 LATHES **LA - metal screen (width to be confirmed with order - max 350mm) - micro with Roller Lever not precabled 14MIC003**

1LA700CM	Side guard for lathe chuck w/micro Dia.700	€ 633,00
1LA800CM	Side guard for lathe chuck w/micro Dia.800	€ 633,00
1LA1000CM	Side guard for lathe chuck w/micro Dia.1000	€ 726,00
1LA1200CM	Side guard for lathe chuck w/micro Dia.1200	€ 726,00
1LA1400CM	Side guard for lathe chuck w/micro Dia.1400	€ 761,00
1LA1600CM	Side guard for lathe chuck w/micro Dia.1600	€ 816,00
1LA1800CM	Side guard for lathe chuck w/micro Dia.1800	€ 864,00

1 TURNING MACHINES

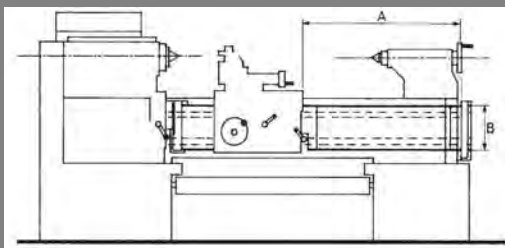

RAL YELLOW 1007

Code	Description	Unit Price
1 LATHES	AR (aramide fabric) Pair (right side + left side)	
1AR500100	Pair of roller-blinds for leadscrew A=500 x B=100 w/metal box 60x60x120mm set	€ 635,00
1AR1500150	Pair of roller-blinds for leadscrew A=1500 x B=150 w/metal box 75x75x200mm set	€ 650,00
1AR1500200	Pair of roller-blinds for leadscrew A=1500 x B=200 w/metal box 75x75x275mm set	€ 650,00
1AR2000200	Pair of roller-blinds for leadscrew A=2000 x B=200 w/metal box 75x75x275mm set	€ 650,00
1AR3000250	Pair of roller-blinds for leadscrew A=3000 x B=250 w/metal box 80x80x300mm set	€ 880,00
1AR4000250	Pair of roller-blinds for leadscrew A=4000 x B=250 w/metal box 105x105x300mm set	€ 1.160,00
1AR5000250	Pair of roller-blinds for leadscrew A=5000 x B=250 w/metal box 105x105x350mm set	€ 1.160,00
1AR4000300	Pair of roller-blinds for leadscrew A=4000 x B=300 w/metal box 105x105x400mm set	€ 1.405,00
1AR5000300	Pair of roller-blinds for leadscrew A=5000 x B=300 w/metal box 105x105x400mm set	€ 1.405,00
1AR6000350	Pair of roller-blinds for leadscrew A=6000 x B=350 w/metal box 140x140x450mm set	€ 1.590,00

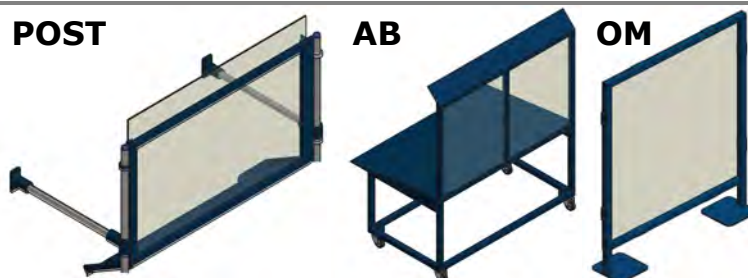
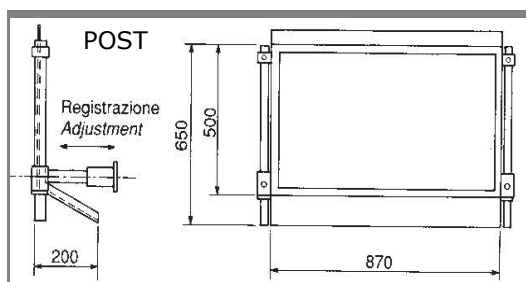

RAL BLU 5010

1 LATHES	POST	
1POST	Rear guard for lathe (panel width 870 x total h 650mm)	€ 715,00
1 LATHES	AB	
1AB	Rear guard (polycarbonate panel 1000x1000mm + feet h500mm = total h1500mm)	€ 1.375,00
1 LATHES	OM	
1OM	Polycarbonate panel for working areas (1200x1200 + feet h200mm = total h1600mm)	€ 781,00



1 LATHES	LE (bar type: square, hex. or round to be confirmed with the order)	
1LEC	Safety lever for the lathe carriage	€ 475,00
1LET	Safety lever for the lathe headstock	€ 475,00
1LE2CT	Double safety levers under headstock and carriage	€ 950,00

1 TURNING MACHINES



Code	Description	Unit Price
1 LATHES	CSA	
1CSA9	Safety key for chucks 9mm square	€ 230,00
1CSA10	Safety key for chucks 10mm square	€ 230,00
1CSA11	Safety key for chucks 11mm square	€ 230,00
1CSA12	Safety key for chucks 12mm square	€ 230,00
1CSA13	Safety key for chucks 13mm square	€ 230,00
1CSA14	Safety key for chucks 14mm square	€ 230,00
1CSA15	Safety key for chucks 15mm square	€ 230,00

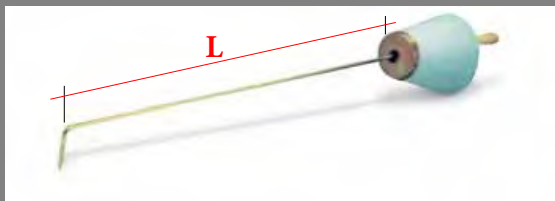

1 LATHES	FI	
1FI	Swarf hook L=500	€ 152,00



RAL YELLOW 1007
RAL RED 3001

1 LATHES	PED - (bar length to be confirmed with the order - max length 2000mm)	
1PED	Emergency pedal for lathe stop	€ 425,00



RAL YELLOW 1007

1 LATHES	TAO	
1TAOSM	Guard for bar passage hole without micro	€ 192,00

1 TURNING MACHINES



RAL YELLOW 1007

Code	Description	Unit Price
TWOOD guard for wood working lathes - micro w/roller lever not precabled 14MIC003		
1 LATHES	Fitting on the back side of the machine	price on request
1TWCM	Guard for lathe w/micro and gas spring - sliding screen 800x330x210mm Suitable also for traditional lathes: version an price on request	



RAL YELLOW 1007

MINOR FIX safety guard for small lathes - micro for hinge 14MIC008		
1 LATHES	Fitting on the back side of the machine	price on request
1MFXCM	Guard for lathe w/micro, w/gas spring w/led lamp 5W Liftable screen 560x75xh1040mm (adjustable height + 500mm = max h1540mm)	

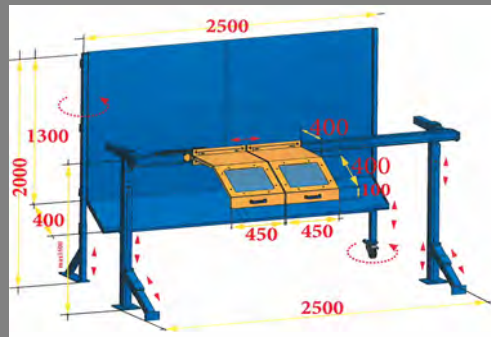

RAL YELLOW 1007
RAL BLU 5010

1LATHES	SD (chuck guard with micro - carriage guard without micro) - micro with L-Type key 14MIC004	
1SDCM	Sliding guards with two glass screens and led light on the carriage screen.	€ 2.915,00
1SDPOST	Rear panel length 2500 x h1300 with chip tray 400mm for back protection on SD guard	€ 1.670,00

2 MILLING MACHINES

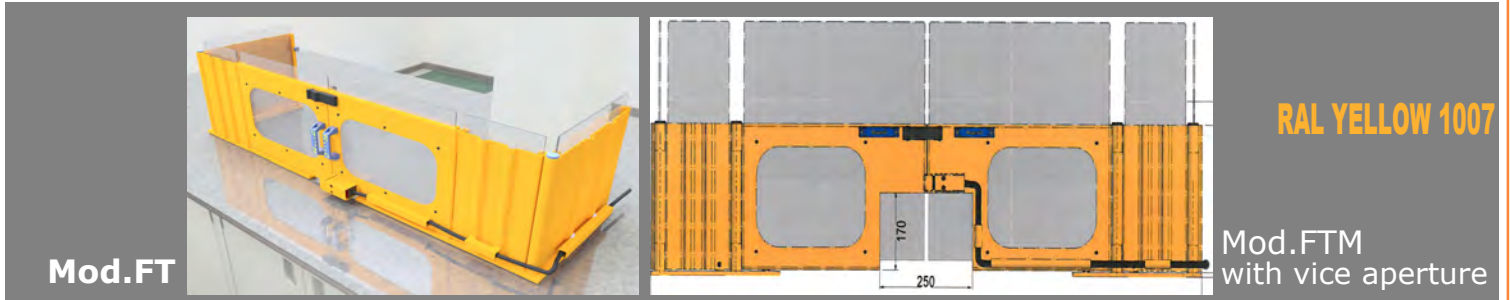

Code	Description	Unit Price
2 MILLING M.	FT -FTM poly doors - micro with L-Type Key 14MIC004	
2FT1CM	Table guard w/micro front.1000mm side 500mm x h 330/630 *	price on request
2FT2CM	Table guard w/micro front.1000mm side 501/800mm x h 330/630*	price on request
2FTM1CM	Table guard w/micro front.1000mm side 500mm x h 330/630+ vice aperture	price on request
2FTM2CM	Table guard w/micro front.1000mm side 501/800mm x h 330/630 +vice aperture	price on request
	H= 330mm adjustable up to h 630mm w/poly panels on front and sides -height cannot be modified	

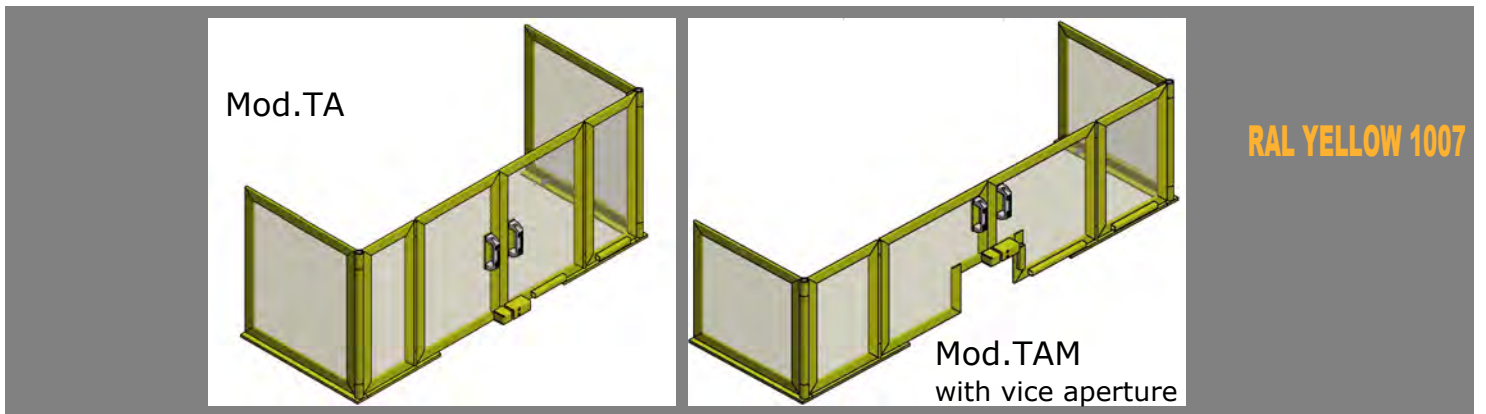

Code	Description	Unit Price
2 MILLING M.	TA -TAM -poly panels -micro with L-Type Key 14MIC004	
2TA1CM	Table guard w/micro front 1000 x side 500 x h300mm	price on request
2TA2CM	Table guard w/micro front 1000 x side 500 x h400mm	price on request
2TA3CM	Table guard w/micro front 1000 x side 500 x h500mm	price on request
2TAM1CM	Table guard w/micro front 1000 x side 500 x h300mm+ vice aperture	price on request
2TAM2CM	Table guard w/micro front 1000 x side 500 x h400mm+ vice aperture	price on request
2TAM3CM	Table guard w/micro front 1000 x side 500 x h500mm+ vice aperture	price on request

2 MILLING MACHINES

RAL YELLOW 1007



Flat screen

Code	Description	Unit Price
2 MILLING M.	FB- poly screen h240mm - 2 microsw. w/piston 14MIC001 - Right or left hand fitting to be specified in PO	
2FB300CMRH	Spindle guard w/2 microsw. - screen dia. 300mm RH (Right Hand fitting)	€ 764,00
2FB350CMRH	Spindle guard w/2 microsw. - screen dia. 350mm RH	€ 764,00
2FB400CMRH	Spindle guard w/2 microsw. - screen dia. 400mm RH	€ 764,00
2FB450CMRH	Spindle guard w/2 microsw. - screen dia. 450mm RH	€ 792,00
2FB500CMRH	Spindle guard w/2 microsw. - screen dia. 500mm RH	€ 792,00
2FB600CMRH	Spindle guard w/2 microsw. - screen dia. 600mm RH	€ 792,00
.....LH	Left hand fitting	
2FB600FCMRH	Spindle guard w/2 microsw. - flat screen 600mm x h 400mm RH	€ 792,00
.....LH	Left hand fitting	
15LLS10	FB/Round Screen - extra charge for Led Light System 20W	€ 285,00
15LLS7	FB/Flat Screen - extra charge for LED Light System 5W	€ 285,00

RAL YELLOW 1007



Flat screen

Code	Description	Unit Price
2 MILLING M.	FBB with balanced arm. poly screen h240mm 2 microsw. w/piston 14MIC001 -1 micro w/roller lever precabled 14MIC002	Right or left hand fitting to be specified in PO
2FBB300CMRH	Spindle guard w/3 microsw. - screen dia. 300mm/gas spring RH (Right Hand fitting)	€ 927,00
2FBB350CMRH	Spindle guard w/3 microsw. - screen dia. 350mm/gas spring RH	€ 927,00
2FBB400CMRH	Spindle guard w/3 microsw. - screen dia. 400mm/gas spring RH	€ 927,00
2FBB450CMRH	Spindle guard w/3 microsw. - screen dia. 450mm/gas spring RH	€ 953,00
2FBB500CMRH	Spindle guard w/3 microsw. - screen dia. 500mm/gas spring RH	€ 953,00
2FBB600CMRH	Spindle guard w/3 microsw. - screen dia. 600mm/gas spring RH	€ 953,00
.....LH	Left Hand fitting	
2FBB600FCMRH	Spindle guard w/3 microsw. - flat screen 600 mm x h 400/gas spring RH	€ 953,00
..... LH	Left Hand fitting	
15LLS10	FBB/Round Screen - extra charge for Led Light System 20W	€ 225,00
15LLS7	FBB/Flat Screen - extra charge for Led Light System 5W	€ 225,00

2 MILLING MACHINES

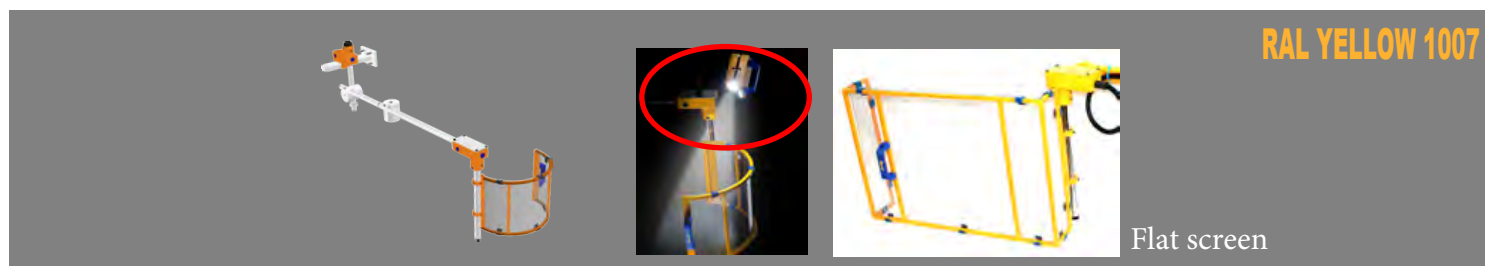

Code	Description	Unit Price
2 MILLING M.	FA -poly screen h240mm h 240 - 2 microsw. with piston 14MIC001 Right or left hand fitting to be specified in PO	
2FA300CMRH	Spindle guard w/2 microsw. - screen dia. 300mm RH (Right Hand fitting)	€ 745,00
2FA350CMRH	Spindle guard w/2 microsw. - screen dia. 350mm RH	€ 745,00
2FA400CMRH	Spindle guard w/2 microsw. - screen dia. 400mm RH	€ 745,00
2FA450CMRH	Spindle guard w/2 microsw. - screen dia. 450mm RH	€ 772,00
2FA500CMRH	Spindle guard w/2 microsw. - screen dia. 500mm RH	€ 772,00
2FA600CMRH	Spindle guard w/2 microsw. - screen dia. 600mm RH	€ 772,00
.....LH	Left Hand fitting	
2FA600FCMRH	Spindle guard w/2 microsw. - flat screen 600 mm x h 400 mm RH	€ 772,00
.....LH	Left Hand fitting	
15LLS10	FA/Round Screen - extra charge for Led Light System 20W	€ 225,00
15LLS7	FA/Flat Screen - extra charge for Led Light System 5W	€ 225,00

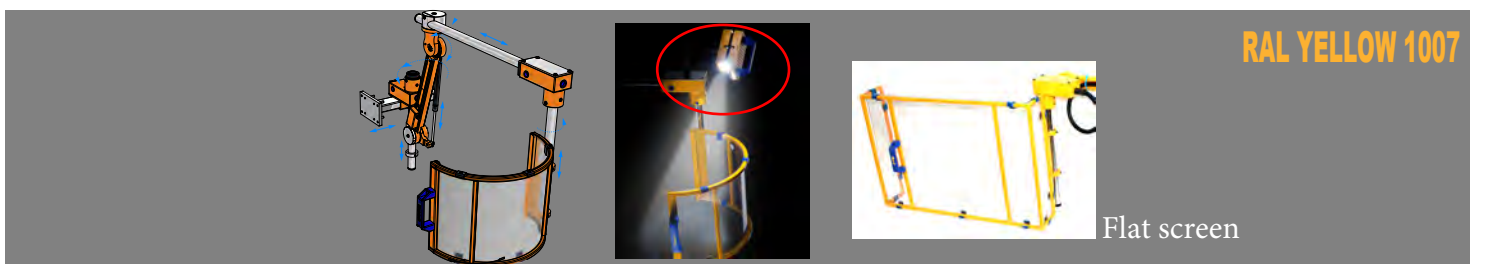

2 MILLING M.	FAB with balanced arm. poly screen h240mm 2 microsw. w/piston 14MIC001 -1 micro w/roller lever precabled 14MIC002 Right or left hand fitting to be specified in PO	
2FAB300CMRH	Spindle guard w/3 microsw./screen dia. 300/gas spring RH (Right Hand)	€ 903,00
2FAB350CMRH	Spindle guard w/3 microsw./screen dia. 350/gas spring RH	€ 903,00
2FAB400CMRH	Spindle guard w/3 microsw./screen dia. 400/gas spring RH	€ 903,00
2FAB450CMRH	Spindle guard w/3 microsw./screen dia. 450/gas spring RH	€ 931,00
2FAB500CMRH	Spindle guard w/3 microsw./screen dia. 500/gas spring RH	€ 931,00
2FAB600CMRH	Spindle guard w/3 microsw./screen dia. 600/gas spring RH max dia. 600mm	€ 931,00
.....LH	Left Hand fitting	
2FAB600FCMRH	Spindle guard w/3 microsw./flat screen 600 mm x h 400/gas spring RH	€ 931,00
.....LH	Left Hand fitting	
15LLS10	FAB/Round Screen - extra charge for Led Light System 20W	€ 225,00
15LLS7	FAB/Flat Screen - extra charge for Led Light System 5W	€ 225,00

2 MILLING MACHINES

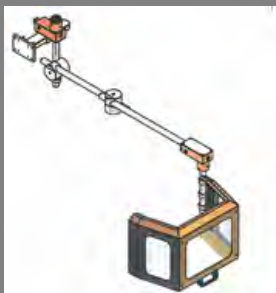

RAL YELLOW 1007

Code	Description	Unit Price
2 MILLING M.	AF -poly or glass screens - 2 microsw. with piston 14MIC001 Right or left hand fitting to be specified in PO	
2AF450PCMRH	Spindle guard w/2 microsw.-poly.screen dia. 450 x h 310mm RH (Right Hand fitting)	€ 913,00
2AF450VCMRH	Spindle guard w/2 microsw.-glass screen dia. 450 x h 310mm RH	€ 993,00
2AF600PCMRH	Spindle guard w/2 microsw.-poly. screen dia. 600 x h 310mm RH	€ 939,00
2AF600VCMRH	Spindle guard w/2 microsw.-glass screen dia. 600 x h 310mm RH	€1.019,00
..... LH	Left Hand fitting	
15LLS10	AF - Extra charge x led light system 20W	€ 225,00

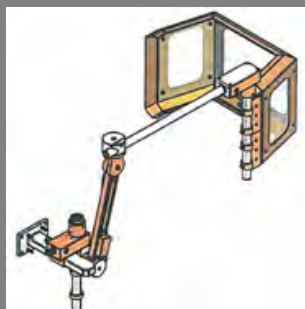

RAL YELLOW 1007

Code	Description	Unit Price
2 MILLING M.	BAF poly or glass screens and balanced arm. Right or left hand fitting to be specified in PO	
	2 microsw. w/piston 14MIC001-1 micro w/roller lever precabled 14MIC002	
2BAF450PCMRH	Spindle guard w/3 microsw.-poly.screen dia.450 x h310mm -gas spring RH(Right Hand Fit.)	€ 1.069,00
2BAF450VCMRH	Spindle guard w/3 microsw.-glass screen dia.450 x h310mm -gas spring RH	€ 1.149,00
2BAF600PCMRH	Spindle guard w/3 microsw.-poly.screen dia.600 x h310mm -gas spring RH	€ 1.099,00
2BAF600VCMRH	Spindle guard w/3 microsw.-glass screen dia.600 x h310mm -gas spring RH	€ 1.179,00
..... LH	Left Hand fitting	
15LLS10	BAF - Extra charge for led light system 20W	€ 225,00

2 MILLING MACHINES



RAL YELLOW 1007

Code	Description	Unit Price
2 MILLING M.	BF poly or glass screens - 2 microswitches with piston 14MIC001	Right or left hand fitting to be specified in PO
2BF450PCMRH	Spindle guard w/ 2 microsw.-poly.screen dia.450 x h310mm RH (Right Hand fitting)	€ 927,00
2BF450VCMRH	Spindle guard w/ 2 microsw.-glass screen dia.450 x h310mm RH	€ 1.007,00
2BF600PCMRH	Spindle guard w/ 2 microsw.-poly.screen dia.600 x h310mm RH	€ 955,00
2BF600VCMRH	Spindle guard w/ 2 microsw.-glass.screen dia.600 x h310mm RH	€ 1.035,00
..... LH	Left Hand fitting	
15LLS10	BF - Extra charge x led light system 20W	€ 225,00

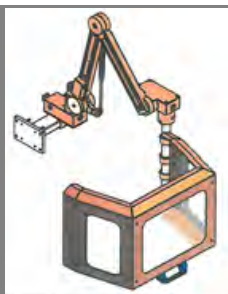

RAL YELLOW 1007

Code	Description	Unit Price
2 MILLING M.	BBF poly or glass screens and balanced arm. 2 microsw. w/piston 14MIC001 - 1 micro w/roller lever precabled 14MIC002	Right or left hand fitting to be specified in PO
2BBF450PCMRH	Spindle guard w/ 2 microsw.-poly.screen dia.450 x h310mm RH (Right Hand fitting)	€ 1.088,00
2BBF450VCMRH	Spindle guard w/ 2 microsw.-glass screen dia.450 x h310mm RH	€ 1.168,00
2BBF600PCMRH	Spindle guard w/ 2 microsw.-poly.screen dia.600 x h310mm RH	€ 1.118,00
2BBF600VCMRH	Spindle guard w/ 2 microsw.-glass.screen dia.600 x h310mm RH	€1.198,00
..... LH	Left Hand fitting	
15LLS10	BBF - Extra charge x led light system 20W	€ 225,00

2 MILLING MACHINES

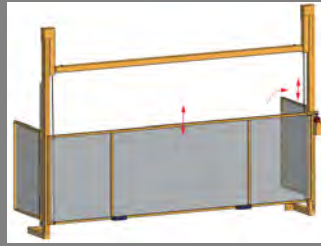

RAL YELLOW 1007

Code	Description	Unit Price
2 MILLING M.	FV table guard (vertical sliding)-metal micro with L-Type key 14MIC004M	
2FV1CM	Vertically sliding guard: width up to 1000mm-panel H600mm-total H1270mm w/counterweight	€ 1.858,00
2FV2CM	Vertically sliding guard: width 1001 up to 1600mm-panel H600mm-total H1270mm w/counterw.	€ 2.198,00
2FV3CM	Vertically sliding guard: width 1601 up to 2000mm-panel H600mm-total H1270mm w/counterw.	€ 2.516,00
	Deduction for guard without sides	€ 60,00

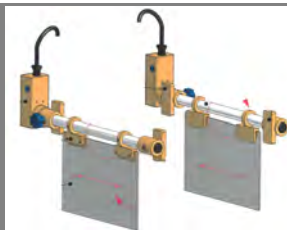

RAL YELLOW 1007

2 MILLING M.	FR - poly. screens - Horizontal spindle guards - 2 micros with piston 14MIC001	
2FR1CM	Pair of tiltable guards for horizontal spindle 300 x h200mm w/2 microswitches	€ 595,00
2FR2CM	Pair of tiltable guards for horizontal spindle 400 x h200mm w/2 microswitches	€ 615,00
2FR3CM	Pair of tiltable guards for horizontal spindle 300 x h250mm w/2 microswitches	€ 619,00
2FR4CM	Pair of tiltable guards for horizontal spindle 400 x h300mm w/2 microswitches	€ 645,00
2FR5CM	Pair of tiltable guards for horizontal spindle 500 x h300mm w/2 microswitches	€ 679,00
2FR6CM	Pair of tiltable guards for horizontal spindle 600 x h350mm w/2 microswitches	€ 745,00



RAL YELLOW 1007

2 MILLING M.	FAO - Drawbar cap - micro with L-Type key 14MIC004	
2FAOSM	Guard for upper/rear milling machine drawbar without micro	€ 348,00
2FAOCM	Guard for upper/rear milling machine drawbar with micro	€ 428,00



RAL YELLOW 1007

2 MILLING M.	PED (bar length to be provided with the purchase order - up to max. 2000mm)	
2PED	Emergency foot bar for machine stop	€ 425,00

3 DRILLING MACHINES



RAL YELLOW 1007

Code	Description	Unit Price
3 DRILLING M. TR1- poly screen - standard fitting on the left side - micro with roller lever precabled 14MIC002		
3TR1CM	Drilling machine guard, small screen 130 x h200mm w/micro. polycarbonate 5mm	€ 199,00
3TR1SM	Drilling machine guard, small screen 130 x h200mm no micro. polycarbonate 5mm	€ 149,00

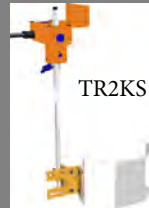

RAL YELLOW 1007

3 DRILLING M. TR2 - poly screen - standard fitting on the left side - micro w/piston 14MIC001 with micro w/out micro		
3TR2CM	Drilling machine guard, screen 200 x h130mm w/micro. poly. screen 4mm	€ 302,00 € 252,00
3TR2KS-CM	Drilling machine guard, screen 200 x h130mm w/micro w/2 ad.brackets x poly. screen 4mm	€ 362,00 € 312,00
3TR2CMDS	Drilling machine guard, double screen 130xh200mm w/micro.	€ 362,00 € 312,00



RAL YELLOW 1007

3 DRILLING M. TR2SP - poly screen - standard fitting on the left side - micro w/roller lever precabled 14MIC002		
3TR2SPCM	Drilling machine guard, screen 200 x h130mm w/micro - compact support. poly.scr. 4mm	€ 302,00 € 252,00
3TR2SP-KSCM	Drilling machine guard, screen 200 x h130mm w/micro w/2 adj.brackets poly. scr. 4mm	€ 362,00 € 312,00
3TR2-KSPCM	Drilling machine guard, screen 200 x h130mm w/micro - w/4-adjust. brackets poly. scr. 4mm	€ 417,00 € 367,00
3TR2SPCMDS	Drilling machine guard, compact support, double screen 200 x h130mm w/micro	€ 362,00 € 312,00

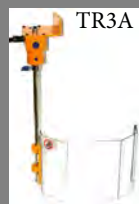

RAL YELLOW 1007

3 DRILLING M. TR3A - poly. screen - standard fitting on the left side - micro w/piston 14MIC001 with Micro w/out Micro		
3TR3ACM	Guard for radial boring mach. screen 300 x h200mm w/micro. poly. screen 4mm	€ 320,00 € 270,00
3TR3AKS-CM	Guard for radial boring mach. screen 300 x h200mm w/micro w/2 ad.brackets x poly scr.	€ 380,00 € 330,00

3 DRILLING M. TR3ASP - poly. screen - standard fitting on the left side - micro w/roller lever precabled 14MIC002		
3TR3ASPCM	Guard for radial boring m.,screen 300xh200mm w/micro - compact support poly.scr.4mm	€ 320,00 € 270,00
3TR3ASP KS-CM	Guard for radial boring mach., screen 300xh200mm w/micro,w/2 ad.brackets,poly scr.	€ 380,00 € 330,00

3 DRILLING MACHINES



RAL YELLOW 1007

Code	Description	Unit Price
3 DRILLING M.	TR5-poly. screen-standard fitting on the left side-micro w/roller lever precabled 14MIC002 with micro w/out micro	
3TR5CM	Drilling machine guard, screen 230 x h310 w/micro. poly. 5mm	€ 265,00 € 215,00



RAL YELLOW 1007

3 DRILLING M.	TR6-poly.screen-standard fitting on the left side-micro w/roller lever precabled 14MIC002 with micro w/out micro	
3TR6CM	Drilling machine guard, screen 170 x h200 w/micro. poly. 5mm	€ 218,00 € 168,00

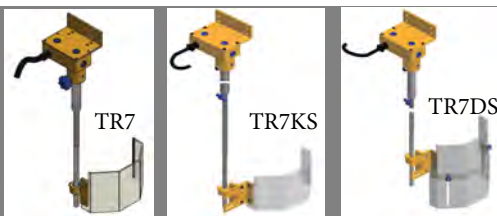

Telescopic hexagonal rod

RAL YELLOW 1007

3 DRILLING M.	TR7- poly.screen -standard fitting on the left side- micro w/piston 14MIC001 with micro w/out micro	
3TR7CM	Drilling machine guard, screen 200 x h130 w/micro. poly. screen 4mm	€ 302,00 € 252,00
3TR7-KS-CM	Drilling machine guard, screen 200 x h130 w/micro w/2 adjusting brackets, poly.scr.	€ 362,00 € 312,00
3TR7CMDS	Drilling machine guard, double screen 130xh200mm w/micro.	€ 362,00 € 312,00

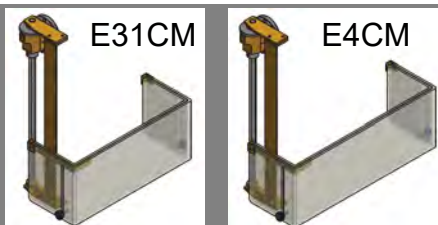

RAL YELLOW 1007

3 DRILLING M.	TR - poly.screen - standard fitting on the left side - micro w/roller lever precabled 14MIC002 with Micro w/out Micro	
3TRE31CM	Drilling machine guard with double screen 350x135h150mm poly. scr.5mm	€ 475,00 € 425,00
3TRE4CM	Drilling machine guard with double screen 420x135h150mm poly. scr.5mm	€ 475,00 € 425,00



TR8CM

RAL YELLOW 1007

Code	Description	Unit Price
3 DRILLING M.	TR poly screen - standard fitting on the left side - micro with piston 14MIC001	
3TR8CM	Guard for radial boring mach. with double attachment -screen 400xh300mm with one micro	€ 549,00

3 DRILLING MACHINES



Code	Description	Unit Price
3 DRILLING M. TR -poly+metal screen- standard fitting on the left side-safety hinge switches -14MIIC009 with Micro		
3TRTCM	Drill/mill guard (Bridgeport style) w/micro 145x160xh160mm (totally closed)	€ 355,00
3TR2TCM	Drilling mach. guard, poly.screen 6mm w/micro 220xh130mm compact support (totally closed)	€ 355,00

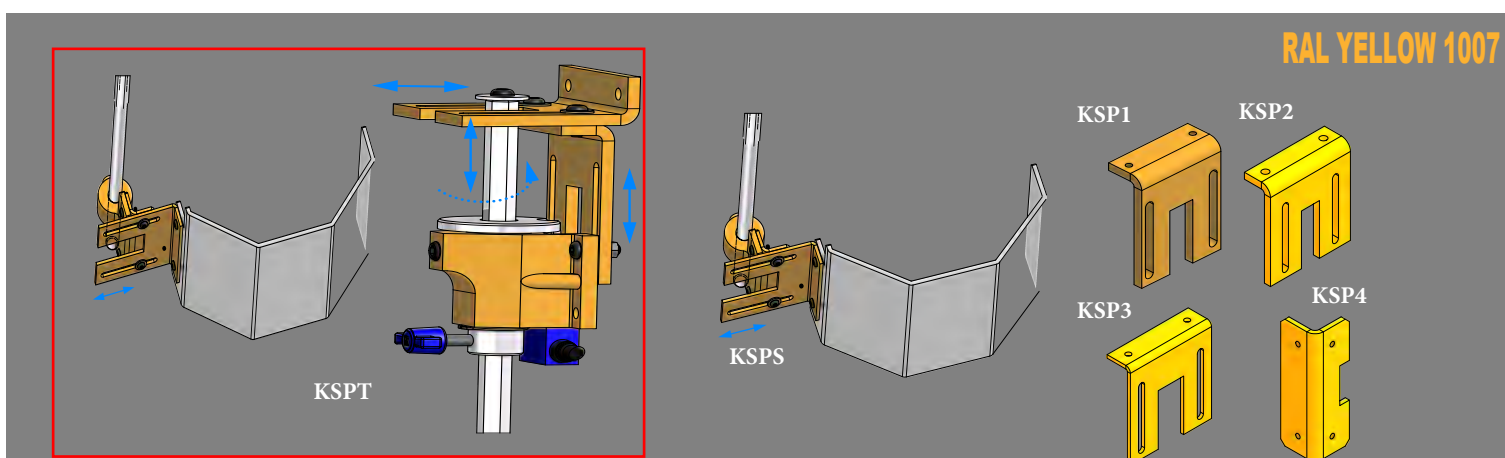

3KSPT	Set of 4 adjusting brackets only for TR2 & TR7 guards	€ 115,00
3KSPS	Set of 2 adjusting brackets only for TR2 & TR7 screen (KSP3+KSP4)	€ 60,00
	3KSP1 or 3KSP2 or 3KSP3 or 3KSP4 - single bracket to choose from	€ 30,00



3 DRILLING M.	PED - (bar length to be provided with the purchase order - up to max. 2000mm)	
3PED	Emergency foot bar for machine stop	€ 425,00

3 DRILLING MACHINES

NEW



RAL YELLOW 1007

Code	Description	Unit Price
3 DRILLING M.	TR poly screen - standard fitting on the left side - safety hinge switches 14MIC009	
3TR9CM	Drilling machine guard with flip-up screen 110x110x110 h140 with micro	€ 322,00
3TR9CMDS	Drilling machine guard with double flip-up screen 110x110x110 min.h140/245 w/micro	€ 387,00

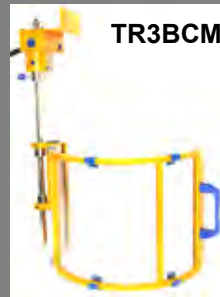

RAL YELLOW 1007

3 DRILLING M.	TR3B poly screen- standard fitting on the left side-micro with piston 14MIC001 with Micro w/out Micro		
3TR3B200CM	Radial drill guard, polycarbonate screen 200 x h240 mm, thickness 2mm	€ 339,00	€ 279,00
3TR3B300CM	Radial drill guard, polycarbonate screen 300 x h240 mm, thickness 2mm	€ 339,00	€ 279,00
3TR3B350CM	Radial drill guard, polycarbonate screen 350 x h240 mm, thickness 2mm	€ 339,00	€ 279,00
3TR3B400CM	Radial drill guard, polycarbonate screen 400 x h240 mm, thickness 2mm	€ 339,00	€ 279,00
3TR3B450CM	Radial drill guard, polycarbonate screen 450 x h240 mm, thickness 3mm	€ 367,00	€ 307,00
3TR3B500CM	Radial drill guard, polycarbonate screen 500 x h240 mm, thickness 3mm	€ 367,00	€ 307,00
3TR3B600CM	Radial drill guard, polycarbonate screen 600 x h240 mm, thickness 3mm	€ 367,00	€ 307,00

option: available with compact support "SP" at the same price



RAL YELLOW 1007

3 DRILLING M.	TR poly. or pvc screen-stand.fitting on the left side-micro w/roller lever precabled 14MIC002 with Micro w/out Micro		
3TRFCM	Drilling machine guard, poly. screen w/micro 307x130xh150mm, poly. thickn. 5mm	€ 335,00	€ 285,00
3TRGCM	Drilling machine guard, pvc screen w/micro 230x150xh200mm, pvc thickn. 4mm	€ 335,00	€ 285,00
3TRHCM	Drilling machine guard, pvc screen w/micro 280x150xh200mm, pvc thickn. 4mm	€ 335,00	€ 285,00
3TRKCM	Drilling machine guard, pvc screen w/micro dia.180xh140mm, pvc thickn. 4mm	€ 315,00	€ 265,00
3TRICM	Drilling machine guard, pvc screen w/micro 300x200xh200mm, pvc thickn. 4mm	€ 335,00	€ 285,00
3TRJCM	Drilling machine guard, pvc screen w/micro 280 x 150 x h140mm, pvc thickn. 4mm	€ 335,00	€ 285,00

4 GRINDING MACHINES



PR1



PR2

RAL YELLOW 1007

Code	Description	Unit Price
4 GRINDING M.	PR - polycarbonate screens, rail-mounted doors - electromagnetic micro 14MIC005	
4PR11200	Grinding Mach.Guard 1/screen 600x600mm rail up to 1200mm w/electr.mag.micro	€ 950,00
4PR12000	Grinding Mach.Guard 1/screen 600x600mm rail from 1201 to 2000mm w/electr.mag.micro	€ 1.070,00
4PR13000	Grinding Mach.Guard 1/screen 600x600mm rail from 2001 to 3000mm w/electr.mag.micro	€ 1.200,00
4PR22000	Grinding Mach.Guard 2/screens 600x600mm rail up to 2000mm w/electr.mag.micro	€ 1.514,00
4PR23000	Grinding Mach.Guard 2/screens 600x600mm rail from 2001 to 3000mm w/electr.mag.micro	€ 1.644,00
4PR25000	Grinding Mach.Guard 2/screens 600x600mm rail from 3001 to 5000mm w/electr.mag.micro	€ 1.820,00
14MICBOX001	The Control Box MICBOX001 is needed to operate the electrectromagnetic micro	€ 620,00

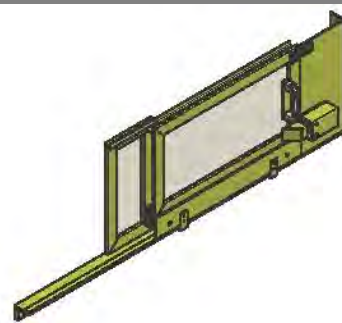
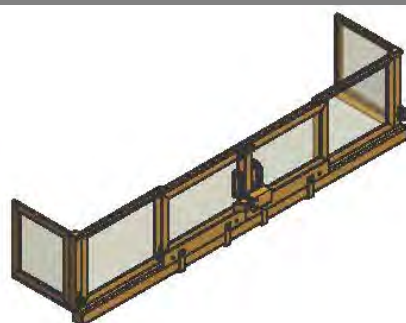
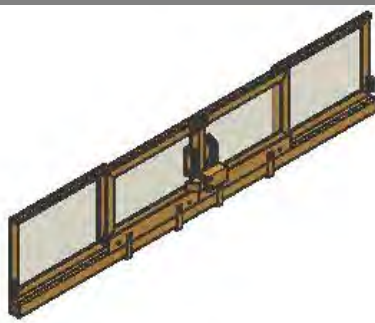

RAL YELLOW 1007

4 GRINDING M.	TA-SLY- polycarbonate panels - one or two sliding doors - electromagnetic micro 14MIC005	
4TA1SLYCM	Sliding guard w/electromagnetic micro h300 - front side up to 1000mm	price on request
4TA2SLYCM	Sliding guard w/electromagnetic micro h400 - front side up to 1000mm	price on request
4TA3SLYCM	Sliding guard w/electromagnetic micro h500 - front side up to 1000mm	price on request
14MICBOX001	The Control Box MICBOX001 is needed to operate the electrectromagnetic micro	€ 620,00

5 SAWING MACHINES

RAL YELLOW 1007

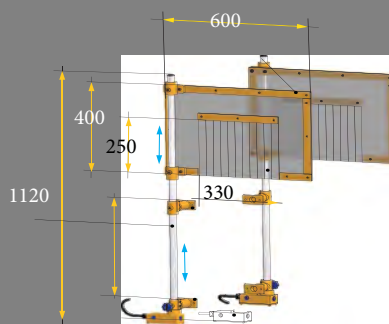

Code	Description	Unit Price
5 SAWING M.	PS - polycarbonate screens - 2 microswitches with piston 14MIC001	
5PS1CM	Sawing mach. guard 600x400mm w/2 microswitches (pair)	set € 840,00

6 BORING MACHINES

RAL YELLOW 1007

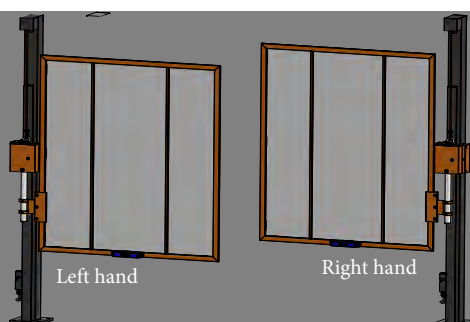

6 BORING M.	AL - poly. screen (left or right hand mounting) - micro with L-Type Key 14MIC004	
6AL1CMRH	Single guard for boring mill w/micro RH screen 800xh900mm (Right Hand)	€ 1.987,00
6AL2CMRH	Single guard for boring mill w/micro RH screen 800xh1000mm	€ 1.998,00
6AL3CMRH	Single guard for boring mill w/micro RH screen 800xh1200mm	€ 2.084,00
..... LH	Left hand fitting Right or left hand fitting to be specified in PO	

7 OFF-HAND GRINDERS

RAL YELLOW 1007

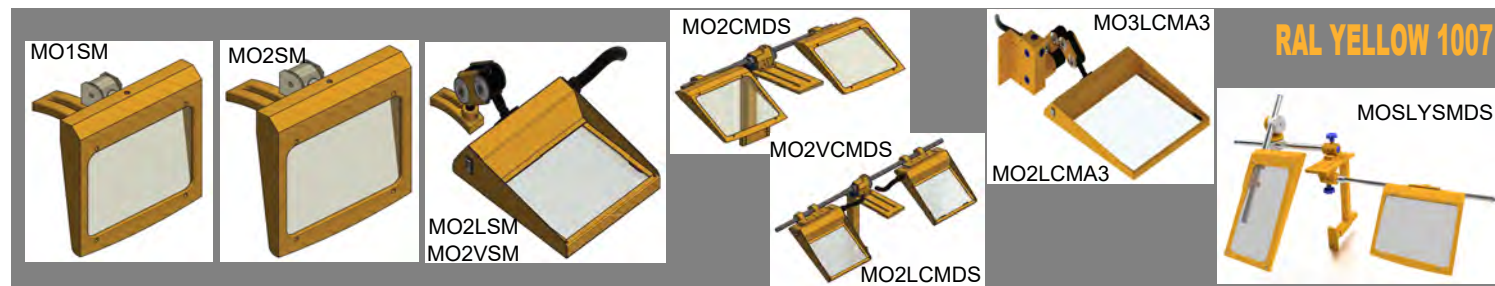

7 GRINDERS	MO - polycarbonate or glass screen - with or without micro	
7MO1SM	Guard x Grinder single polycarbonate screen 150x160mm no micro	€ 94,00
7MO2SM	Guard x Grinder single polycarbonate screen 200x210mm no micro	€ 140,00
7MO2VSM	Guard x Grinder single glass screen 200x240mm no micro	€ 255,00
7MO2LSM	Guard x Grinder single glass screen 200x240mm no micro w/light	€ 315,00
7MO2CM-DS	Guard x Grinder Double Poly. Screens 200x210mm -micro w/roller lever prec.14MIC002	€ 542,00
7MO2VCM-DS	Guard x Grinder Double Glass Screens 200x240mm -micro w/roller lever prec.14MIC002	€ 642,00
7MO2LCM-DS	Guard x Grinder Double Glass Screens 200x240mm w/light-micro w/roller lev. prec.14MIC002	€ 780,00
7MO2LCMA3	Guard x Grinder single glass screen 200x240mm w/light -micro w/piston 14MIC001	€ 450,00
7MO3LCMA3	Guard x Grinder single glass screen 300x350mm w/light -micro w/piston 14MIC001	€ 495,00
7MOSLYSMDS	Guard x Grinder Double Poly. Sliding Scr. -Left 200xh400mm -Right 200 xh210mm-no micro	€ 567,00

8 UNIVERSAL APPLICATIONS-TOP LINE

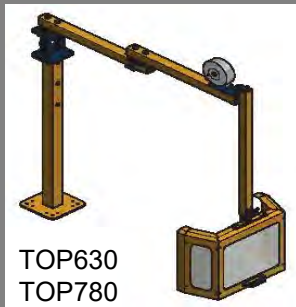

TOP630
TOP780

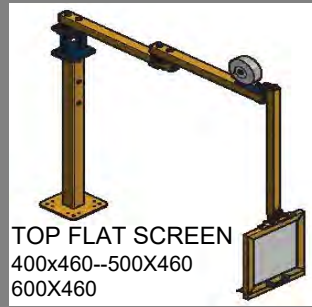

TOP FLAT SCREEN
400x460--500X460
600X460

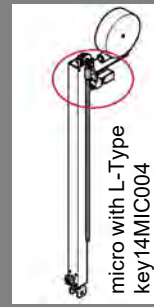

micro with L-Type
key 14MIC004

RAL YELLOW 1007

Code	Description	Unit Price
8 TOP LINE	Universal guard suitable for various kinds of applications - w/flexible mobile arm -w/counter-weight & glass screen	

prices on request

9 HYDRAULIC PRESSES

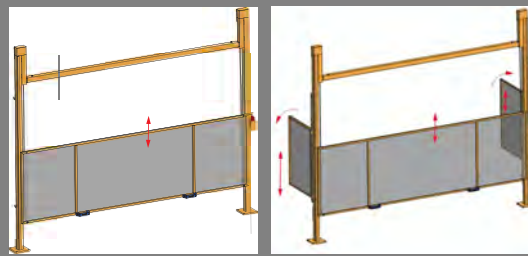

RAL YELLOW 1007

"dimensions on request"

9 HYDR.PRESS	FVH -poly panel - Vert slid.guard (with or without sides) -metal micro w/L-Type Key 14MIC004M	
9FVH1CM	Guard for hydraulic presses w/micro panel width 1000 mm	€ 1.950,00
9FVH1SM	Guard for hydraulic presses no micro panel width 1000 mm	€ 1.890,00
9FVH2CM	Guard for hydraulic presses w/micro panel width from 1001 up to 1600 mm	€ 2.300,00
9FVH2SM	Guard for hydraulic presses no micro 1001/1600 mm	€ 2.240,00
9FVH3CM	Guard for hydraulic presses w/micro 1601/2000 mm	€ 2.620,00
9FVH3SM	Guard for hydraulic presses no micro 1601/2000 mm	€ 2.560,00

Deduction for FVH without sides € 60,00

9 ECCENTRIC PRESSES





RAL YELLOW 1007

"dimensions on request"

9 ECCENTRIC PR.	PP - polycarb.panels + removable rods (special dimensions on request) - Coded micro 14MIC006	
9PP1CM	Guard with coded micro for presses, dimensions: 700x500xh500mm	€ 1.490,00
9PP2CM	Guard with coded micro for presses, dimensions: 800x600xh700mm	€ 1.790,00
9PP3CM	Guard with coded micro for presses, dimensions: 1000x700xh800mm	€ 1.920,00

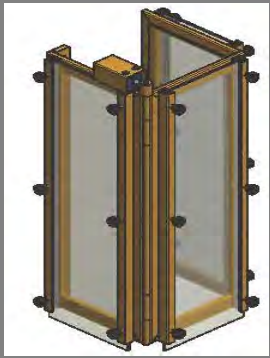
10 SLOTTING MACHINES

			RIGHT HAND RAL YELLOW 1007 <p>"In your PO pls specify, if micro is to be mounted on the left or on the right side"</p>
LEFT HAND			
Code	Description	Unit Price	
10 SLOTTING M.	ST - polycarbonate customized guards - dimensions on request: ask for the drawing to indicate the dimensions		
10ST...CM	ST Slotting machine guard - micro with roller lever not precabled 14MIC003	price on request	

11 ACCESSORIES

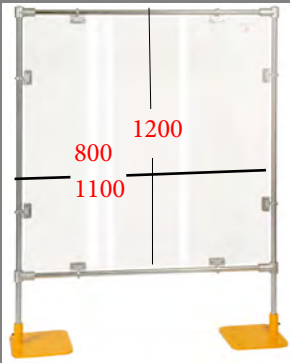
		RAL YELLOW 1007
--	--	------------------------

11 ACCESSORIES	PM polycarbonate panels		
11PM1	Polycarbonate screen 800xh1200xfeed h400mm=total h1600mm		€ 650,00
11PM2	Polycarbonate screen 1100xh1200xfeed h400mm=total h1600mm		€ 730,00

				RAL YELLOW 1007
MSI		RM	LL	

11 ACCESSORIES	Safety screens with magnetic base		
11MSI	Polycarbonate safety screen 350xh300mm w/magnet fixing - 2 positions		€ 374,00
11RM	Polycarbonate safety screen 300xh230mm w/magnet fixing		€ 210,00
11LL	Polycarbonate safety screen 300xh215mm w/magnet fixing		€ 210,00

11 ACCESSORIES

SPIDER 50 & 75 Safety Belt Sanders for Lathes

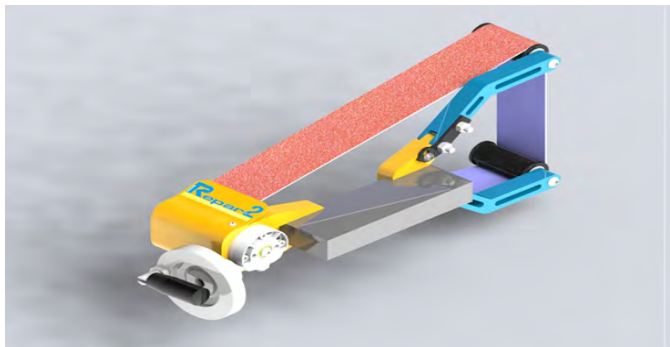
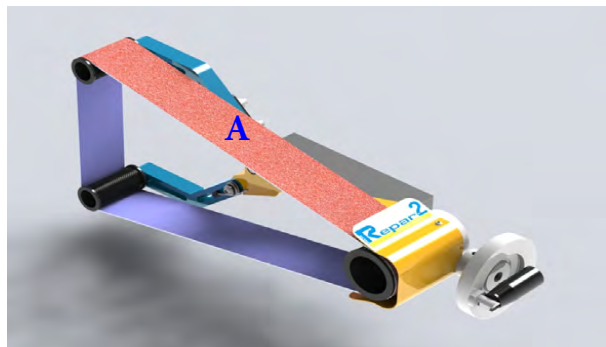
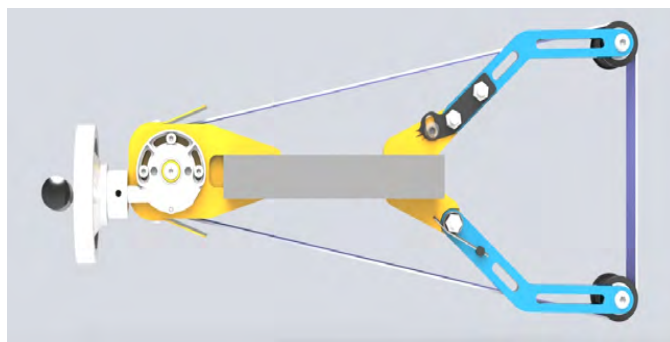
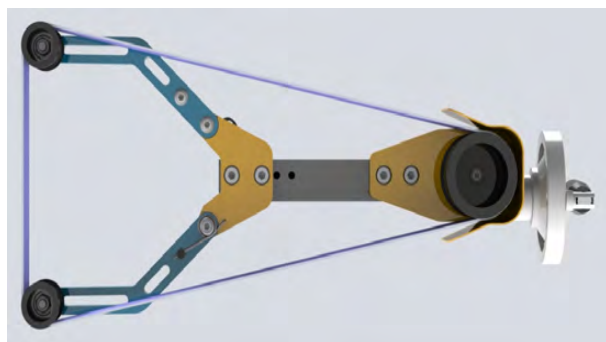

11 ACCESSORIES SPIDER 50 Safety Belt Sander for Lathes

11SPIDER50	Safety Belt Sander 900x50mm complete with 3 spare belts, grit grade 80/120/220	€ 1.156,00
------------	--	------------

11 ACCESSORIES SPIDER 75 Safety Belt Sander for Lathes

11SPIDER75	Safety Belt Sander 1100x75mm complete with 3 spare belts, grit grade 80/120/220	€ 1.270,00
------------	---	------------

011B Spare Belts for Spider 50 and 75

011B50x80	Belt for Spider 50 grid 80	€ 13,00
011B50x120	Belt for Spider 50 grid 120	€ 13,00
011B50x220	Belt for Spider 50 grid 220	€ 13,00

011B75x80	Belt for Spider 75 grid 80	€ 23,00
011B75x120	Belt for Spider 75 grid 120	€ 23,00
011B75x220	Belt for Spider 75 grid 220	€ 23,00

12 FOOT BOARDS - PA

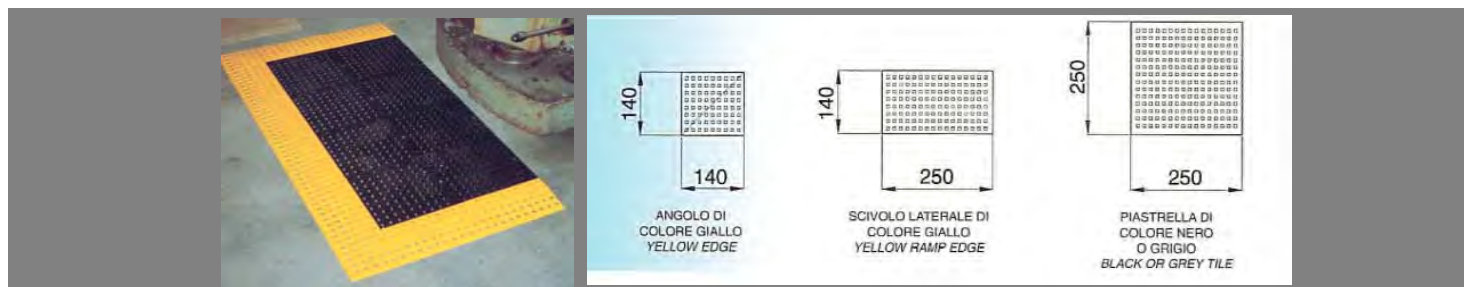

Code	Description	Unit Price
12 FOOT BOARDS PA		
12PA	Anti-skidding complete foot-board 1000 x 500mm	€ 144,00
12PA1	Anti-skidding complete foot-board 1500 x 500mm	€ 192,00
12PA2	Anti-skidding complete foot-board 2000 x 500mm	€ 240,00
12PA3	Anti-skidding complete foot-board 1000 x 750mm	€ 192,00
12PA4	Anti-skidding complete foot-board 1500 x 750mm	€ 256,00
12PA5	Anti-skidding complete foot-board 2000 x 750mm	€ 320,00
12PA6	Anti-skidding complete foot-board 2000 x 1000mm	€ 400,00
12PA7	Anti-skidding complete foot-board 2500 x 750mm	€ 384,00
12PA8	Anti-skidding complete foot-board 3000 x 750mm	€ 448,00
12PA9	Anti-skidding complete foot-board 3500 x 750mm	€ 512,00

12 FOOT BOARDS - loose components to create your own PAD size

12PAP	Black tile 250 x 250 mm	€ 8,00
12PAS	yellow ramp 250 x 140 mm	€ 8,00
12PAA	yellow edge 140 x 140 mm	€ 8,00

12 WOOD-PAD



Code	Description	Unit Price
12 WOOD-PAD Wooden Floor Platform System		
12WP9.1	Wooden Floor Platform System -750x750hx90mm- Kgs. 15	€ 270,00
12WP9.2	Wooden Floor Platform System -1500x750hx90mm- Kgs. 28	€ 470,00

13 PERIMETER GUARDINGS

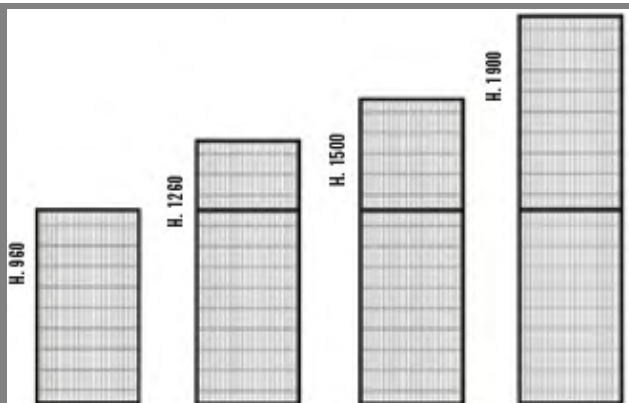

RAL YELLOW 1021

Code	Description	Unit Price
13	ELECTRO-WELDED MESH 22X100mm	
13RT960200	Panel 960 x 200 mm	€ 82,00
13RT960300	Panel 960 x 300 mm	€ 90,00
13RT960700	Panel 960 x 700 mm	€ 102,00
13RT960800	Panel 960 x 800 mm	€ 104,00
13RT9601000	Panel 960 x 1000 mm	€ 108,00
13RT9601200	Panel 960 x 1200 mm	€ 127,00
13RT9601500	Panel 960 x 1500 mm	€ 151,00
13RT1500200	Panel 1500 x 200 mm	€ 86,00
13RT1500300	Panel 1500 x 300 mm	€ 93,00
13RT1500700	Panel 1500 x 700 mm	€ 106,00
13RT1500800	Panel 1500 x 800 mm	€ 108,00
13RT15001000	Panel 1500 x 1000 mm	€ 119,00
13RT15001200	Panel 1500 x 1200 mm	€ 140,00
13RT15001500	Panel 1500 x 1500 mm	€ 173,00
13RT2080200	Panel 1900 x 200 mm	€ 93,00
13RT2080300	Panel 1900 x 300 mm	€ 97,00
13RT2080700	Panel 1900 x 700 mm	€ 108,00
13RT2080800	Panel 1900 x 800 mm	€ 119,00
13RT20801000	Panel 1900 x 1000 mm	€ 127,00
13RT20801200	Panel 1900 x 1200 mm	€ 151,00
13RT20801500	Panel 1900 x 1500 mm	€ 184,00

Panels have no feet as they are fixed to uprights

13 PERIMETER GUARDINGS

RAL YELLOW 1021



Code	Description	Unit Price
13	STEEL-SHEET (full metal panels)	
13LM960200	Panel 960 x 200 mm	€ 195,00
13LM960300	Panel 960 x 300 mm	€ 214,00
13LM960700	Panel 960 x 700 mm	€ 242,00
13LM960800	Panel 960 x 800 mm	€ 252,00
13LM9601000	Panel 960 x 1000 mm	€ 278,00
13LM9601200	Panel 960 x 1200 mm	€ 315,00
13LM9601500	Panel 960 x 1500 mm	€ 353,00
13LM1500200	Panel 1500 x 200 mm	€ 228,00
13LM1500300	Panel 1500 x 300 mm	€ 238,00
13LM1500700	Panel 1500 x 700 mm	€ 264,00
13LM1500800	Panel 1500 x 800 mm	€ 278,00
13LM15001000	Panel 1500 x 1000 mm	€ 299,00
13LM15001200	Panel 1500 x 1200 mm	€ 341,00
13LM15001500	Panel 1500 x 1500 mm	€ 377,00
13LM2080200	Panel 1900 x 200 mm	€ 242,00
13LM2080300	Panel 1900 x 300 mm	€ 252,00
13LM2080700	Panel 1900 x 700 mm	€ 288,00
13LM2080800	Panel 1900 x 800 mm	€ 299,00
13LM20801000	Panel 1900 x 1000 mm	€ 330,00
13LM20801200	Panel 1900 x 1200 mm	€ 365,00
13LM20801500	Panel 1900 x 1500 mm	€ 415,00

Panels have no feet as they are fixed to uprights

13 PERIMETER GUARDINGS



RAL YELLOW 1021

Code	Description	Unit Price
13	POLYCARBONATE - thickness 4mm	
13LX960200	Panel 960 x 200mm	€ 205,00
13LX960300	Panel 960 x 300mm	€ 221,00
13LX960700	Panel 960 x 700mm	€ 289,00
13LX960800	Panel 960 x 800mm	€ 312,00
13LX9601000	Panel 960 x 1000mm	€ 370,00
13LX9601200	Panel 960 x 1200mm	€ 437,00
13LX9601500	Panel 960 x 1500mm	€ 517,00

13LX1500200	Panel 1500 x 200mm	€ 315,00
13LX1500300	Panel 1500 x 300mm	€ 336,00
13LX1500700	Panel 1500 x 700mm	€ 439,00
13LX1500800	Panel 1500 x 800mm	€ 462,00
13LX15001000	Panel 1500 x 1000mm	€ 543,00
13LX15001200	Panel 1500 x 1200mm	€ 642,00
13LX15001500	Panel 1500 x 1500mm	€ 760,00

13LX2080200	Panel 1900 x 200mm	€ 380,00
13LX2080300	Panel 1900 x 300mm	€ 406,00
13LX2080700	Panel 1900 x 700mm	€ 528,00
13LX2080800	Panel 1900 x 800mm	€ 576,00
13LX20801000	Panel 1900 x 1000mm	€ 650,00
13LX20801200	Panel 1900 x 1200mm	€ 770,00
13LX20801500	Panel 1900 x 1500mm	€ 910,00

Panels have no feet as they are fixed to uprights

13 PERIMETER GUARDINGS

RAL YELLOW 1021

PT1120
PT1660
PT2060

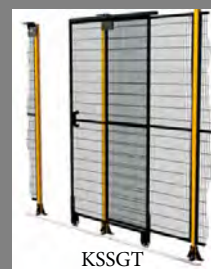
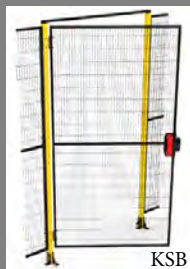

Cod.	Description	Unit Price
13	UPRIGHTS 40 X 40 mm including screws and support kit	
13PT1120	Upright 1120 x 40 x 40	€ 70,00
13PT1660	Upright 1660 x 40 x 40	€ 70,00
13PT2240	Upright 2240 x 40 x40	€ 70,00
	Uprights are complete with fixing feet	
13	KIT for converting panels into doors (cost of the panel not included)	
13KSB	Kit for single wind door - without micro	€ 208,00
13KDB	Kit for double wind door - without micro	€ 315,00
13KSSGS	Kit for single sliding door with upper guide - without micro	€ 456,00
13KDSGSC	Kit for double sliding door with upper guide for right/left opening - without micro	€ 646,00
13KSF	Kit for accordeon door - without micro	€ 538,00
13KSSGT	Kit for single sliding door with lower guide - without micro	€ 689,00
13KDSGTC	Kit for double sliding door wwith lower guide for right/left opening - without micro	€ 1.292,00
13KMICRO	Limit switch micro kit with assembling set (to be ordered for doors)	€ 199,00

NEW

Important notice: with your order for perimeter guarding, pls always send a small sketch of your project.

14 EMERGENCY BOXES-MICROSWITCHES



14 EMERGENCY BOXES / MICROSWITCHES

14BTBOX3HP	Low Voltage Box 3HP 2,25KW	€ 320,00
14BTBOX10HP	Low Voltage Box 10HP 7,5KW	€ 523,00
14BTBOX24HP	Low Voltage Box 24HP 18KW	€ 750,00
14MIC001	Micro with Piston	€ 75,00
14MIC002	Micro with Roller Lever precabled	€ 75,00
14MIC003	Micro with Roller Lever not precabled	€ 75,00
14MIC004	Micro with L-Type key	€ 75,00
14MIC004M	Metal Micro with L-Type key	€ 95,00
14MIC005	Electro-Magnetic Micro	€ 206,00
14MIC006	Coded Micro	€ 206,00
14MIC007	Micro with 4mt Tearing Rope	€ 206,00
14MIC008	Micro for hinge	€ 95,00
14MIC009	Safety hinge switches	€ 210,00
14MICBOX001	Control Box for Electro-Magnetic Micro	€ 620,00
14MICBOXMODULE	Safety Module Box	€ 420,00
14EMBOX	Emergency mushroom stop box	€ 160,00
14EMBUT	Emergency mushroom stop	€ 120,00

NEW



14BTBOX3HP-K	Low Voltage Box 3HP 2,25KW+ key lock	€ 365,00
14BTBOX10HP-K	Low Voltage Box 10HP 7,5KW+ key lock	€ 566,00
14BTBOX24HP-K	Low Voltage Box 24HP 18KW +key lock	€ 792,00

14 EMERGENCY BOXES+SAFETY MODULE



14BTMOD5,5HP	Emergency box low voltage 5,5HP 4KW with safety module two channels + reset button	€ 670,00
14BTMOD10HP	Emergency box low voltage 10HP 7,5KW with safety module two channels + reset button	€ 710,00
14BTMOD24HP	Emergency box low voltage 24HP 18KW with safety module two channels + reset button	€ 810,00

Vertrauen Sie auf über 70 Jahre Erfahrung!

Die Firma HESSE+CO wurde 1947 als Hersteller von Blechbearbeitungsmaschinen gegründet. Seit 1980 sind wir auf den Handel mit neuen sowie gebrauchten Blechbearbeitungs- und Werkzeugmaschinen spezialisiert. Wir haben ständig etwa 300 Maschinen in unserer 2.000 m² großen Ausstellungshalle, die nur 20 Minuten vom internationalen Flughafen Wien entfernt ist.

Trust in more than 70 years of experience!

HESSE+CO was established in 1947 as a manufacturer of sheet metal working machines. Since 1980 we are specialized in dealing with new and second hand sheet metal processing machines and machine tools. We always have approximately 300 machines available in our 2.000 m² showroom, which is located only 20 minutes from the Vienna International Airport, waiting for your inspection.

www.hesse-maschinen.com

