



# GECAM

**Machine Speciali**

---

**Special Machines**

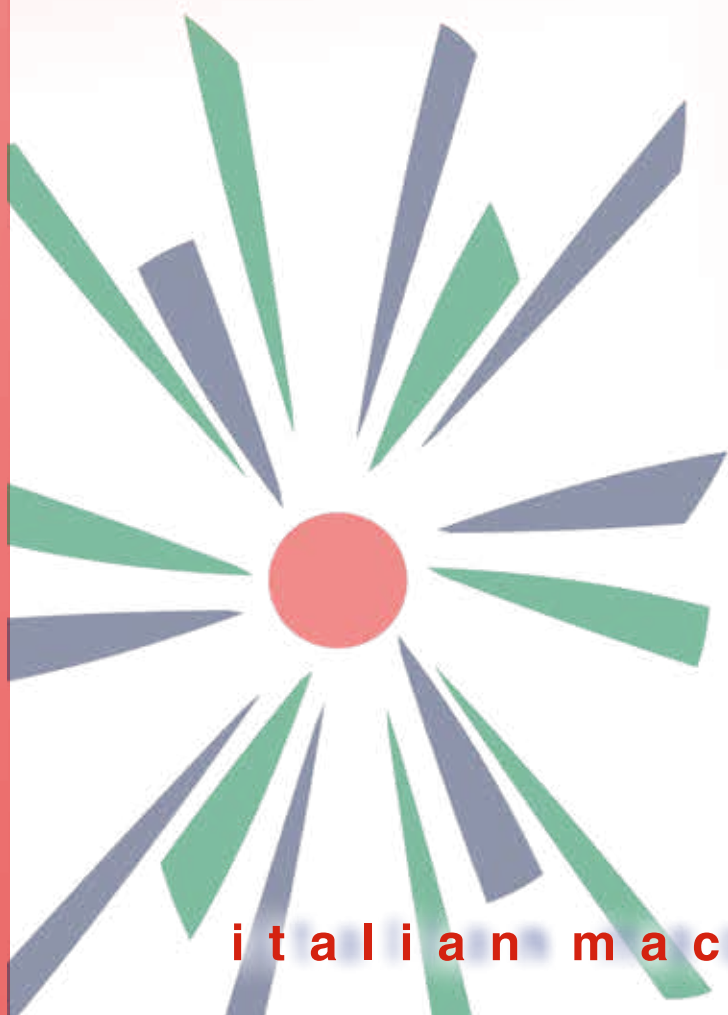

**italian machines and more**



## Special project



 Gecam da sempre pone la massima attenzione alle esigenze di ogni cliente, per questo negli anni ha acquisito una forte riconoscibilità per i progetti di macchine speciali, progettate e realizzate sulle singole esigenze produttive del singolo cliente. Soluzioni customizzate sulla base della reale esigenza di lavorazione del pezzo. Dal 2006 sono oltre 65 i progetti realizzati per clienti da tutto il mondo, con la produzione ogni volta di un singolo prototipo.

Un percorso composto di 6 passi:

- Studio di fattibilità e progetto
- Approvazione del progetto da parte del cliente
- Progettazione
- Produzione
- Installazione e collaudo
- Training

 Gecam always pays the greatest attention to the customers needs, this creates for Gecam the opportunity to acquire a strong recognizability for project of Special machines, designed and produced on the single needs of work of the customer.

Customized solutions based on the real needs of processing of the workpiece. Since 2006 more than 65 different projects realized for customers from all over the world, producing always a single piece that sounds as a prototype.

A route composed of 6 steps:

- Feasibility study and project
- Customer approval of the project
- Design
- Production
- Installation and test
- Training

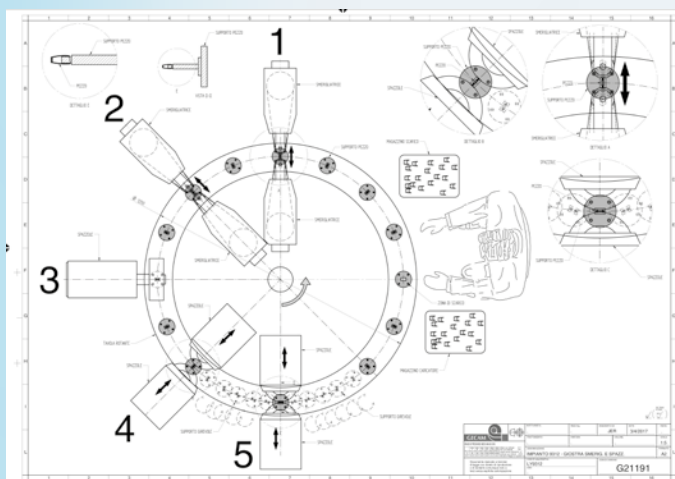

Smerigliatrice a giostra a 9 teste con nastro abrasivo e spazzole per la pulitura di pezzi di 40 mm

Grinding machine with 9 operating heads with abrasive belt and brushes for polishing small pieces of 40 mm

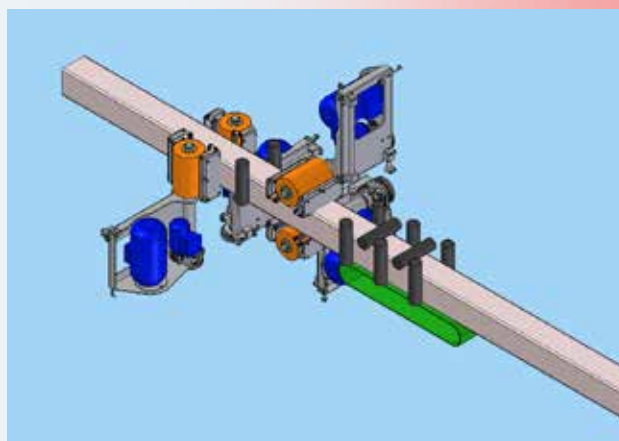

Spazzolatrice a quattro teste per la pulitura di tubi quadri con guida tramite rulli

Brushing machine with 4 operating heads for polishing square tubes guided by rollers

## Robotic cell for grinding edges



watch video



🇮🇹 Sistema completamente motorizzato per smerigliare e pulire spigoli e superfici composto da:

- n. 1 robot a sei assi controllati con un raggio di operazione da 730 a 2650 mm
- n. 6 macchine smerigliatrici con nastro abrasivo su ruote di contatto assemblate a coppie regolabili in altezza e inclinazione in modo da posizionare la ruota di contatto per cui i pezzi possono passare attraverso le varie fasi di lavorazione
- n. 2 smerigliatrici verticali con nastri oscillanti per pulire gli angoli saldati, installate su guide di scorrimenti che avanzano automaticamente verso la posizione di lavoro quando richiesto.
- n.1 macchina saldatrice
- n. 1 spazzolatrice oscillante con spazzola diametro 500 mm e larghezza fino a 1200 mm
- n. 1 spazzolatrice verticale con spazzola diametro 300 mm e larghezza 300 mm per and width up to 300 mm per pulire per zone posteriori vicino ai punti di contatto con le ventose

🇬🇧 Complete motorized system for grinding and polishing corners and surfaces composed by:

- n. 1 robot with 6 controlled axes with an operating range from 730 to 2650 mm
- n. 6 grinding machines with abrasive belt on contact wheels assembled in pairs adjustable in height and tilt so as to position the contact wheel whereby the workpieces can pass through the various processing phases.
- n. 2 vertical grinding machines with oscillating belts for buffing the corners welds, installed on slideways automatically advance towards the work position when required.
- n. 1 oscillating brushing machine with brush diameter 500 mm and width up to 1200 mm
- n. 1 vertical brushing machine with brush diameter 300 mm and width up to 300 mm for polishing the rear areas close to the contact points with the suckers.



## Robotic Cell for polishing kitchen sinks



watch video



🇮🇹 Impianto automatico per smerigliatura e pulitura di lavelli e cappe per cucine contenuto in recinzione con pannelli fonoassorbenti limitato da fotocellule di sicurezza nella zona di carico scarico:

- N.1 Robot Fanuc a sei assi controllati con carico utile al polso fino a 165 kg completo di interfacce di controllo per il nostro sistema elettrico.
- N. 3 macchine smerigliatrici con ruote di contatto con larghezza 150 mm. Ogni macchina è composta da due teste regolabili in altezza e inclinazione per lavorare i pezzi senza creare collisione con le assi del robot. Le teste superiori montano sistema di compensazione sulle ruote
- N.1 spazzolatrice larghezza 800 mm con spazzola scotch brite con sistema di oscillazione assiale.
- N. 1 spazzolatrice larghezza 1200 mm con doppia spazzola da 600 mm in scotch brite due versioni con sistema di oscillazione assiale delle spazzole
- N.1 spazzolatrice larghezza 150 mm con spazzola scotch brite fine per la pulitura finale
- N.1 spazzolatrice larghezza 900 mm con spazzola in tampico e spruzzatore automatico pasta abrasiva
- N.1 filtro aspiratore polveri a secco con sistema a cartuccia con portata 6000 m<sup>3</sup>/h
- Sistema di rilevazione di profondità del pezzo tramite tastatore per la lavorazione in profondità
- Impianto pneumatico dedicato per la gestione delle unità ventose degli organi di presa dei diversi pezzi da lavorare.
- Zona di carico e scarico pezzo con tavolo modulare con parte sostituibile per fissare le diverse maschere degli organi di presa.
- Pannello di controllo elettrico con PLC per gestire le singole macchine dell'impianto separatamente.

🇬🇧 Automatic system for grinding and polishing kitchen hoods and sinks included in a fencing sound deadening with security photocell in the area for loading and unloading, PLC control to manage all machines independently:

- N.1 Robot Fanuc with six axes with payload up to 165kg complete of interfaces for electric system
- N. 3 grinding machines with contact roller with width 150mm. Each machine is equipped with two heads adjustable in height and inclination for processing pieces without any collision with the axis of robot.
- N.1 brushing machine width 800 mm with scotch brite brush and axial oscillation system
- N. 1 brushing machine width 1200 mm with two scotch brite brushes 600 mm with axial oscillation system
- N.1 brushing machine width 900 mm with cotton brush and automatic sprayer for abrasive paste
- N.1 cartridge filter system up to 6000m<sup>3</sup>/h
- Dedicated pneumatic system to manage the single suction unit of the grip members of different workpieces.
- Loader and unloader area with modular table for different clamping systems



## Robotic cell for grinding edges



watch video

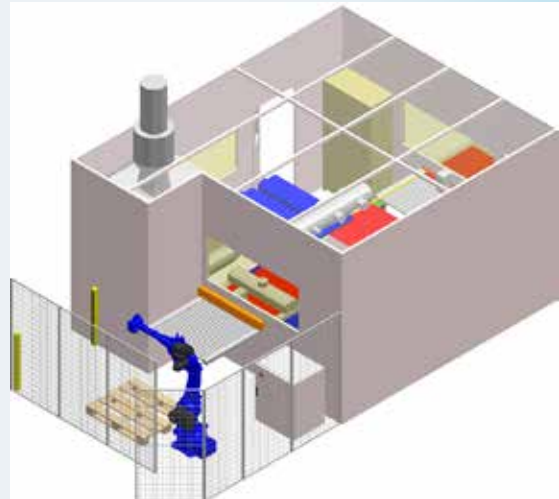

- Impianto robotizzato di smerigliatura all'interno di cabina insonorizzata, completa di quattro teste smerigliatrici con nastro abrasivo a sistema di tensionamento pneumatico, centraggio del nastro abrasivo manuale, rullo di contatto con compensazione pneumatica e oscillazione verticale; due teste smerigliatrici a 45° con nastro abrasivo che lavorano a nastro libero.

Sistema di carico manuale con movimentazione motorizzata comandato da PLC per cambiamento dello spessore da lavorare secondo i parametri del pezzo. Trasportatore a rulli motorizzati dalla macchina al sistema di scarico dove è posizionato robot a 5 assi con raggio di azione di 2655mm.

Spazzola di pulitura superiore posizionata alla fine della linea a sistema di aspirazione con capacità da 6000m<sup>3</sup>/h

Quadro elettrico comandato da PLC Siemens, posizionato alla destra della macchina fuori dalla cabina, che include inverter per velocità variabile di nastro trasportatore.

- The automatic system for grinding included in sound proof cabin, complete of 4 grinding heads with abrasive belt pneumatic tensioning system, manual abrasive belt centering, contact roller with pneumatic compensation and vertical oscillation; 2 grinding heads 45° with abrasive belts processing as free belts.

Manual loading system and motorized carriages managed by PLC for changing working width according to parameters of the piece.

Motorized roller table for moving the piece from the machine to the unloading system, where is positioned a robot with 5 axis with a working radius of 2655 mm.

Top cleaning brush located at the end of the machine and dust collector system with 6000 m<sup>3</sup>/h suction capacity.

The electric cabinet is managed by a Siemens PLC, located at the right position of the machine outside of the cabin, including also the inverters for the variable speed control of the feeding system.



## Grinding machine for clutch disks



watch video

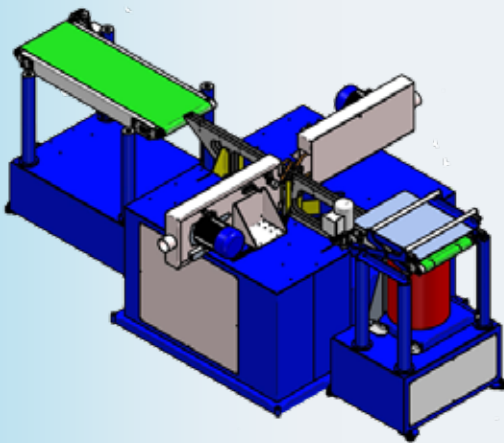

- Macchina progettata per la smerigliatura di dischi frizione, con due teste a nastro abrasivo, composta di 3 moduli e protetta da recinzione accessibile solo attraverso porte con sensori indipendenti e pulsante di emergenza. Sistema di carico e deimpilatore con velocità variabile di salita, discesa e controllata da software. Installato di fronte a nastro trasportatore all'inizio del ciclo di lavoro per carico di gruppo di dischi. Velocità di avanzamento del pezzo controllato da software con inverter. Il gruppo di lavoro è composto da quattro rulli che centrano in disco e lo fanno ruotare su se stesso mentre le due teste con nastro abrasivo si avvicinano all'area sbavare con inclinazione dei nastri a 45° per lavorare su entrambi i lati del disco. Al termine della lavorazione le teste si staccano dal disco che si sposta verso il trasportatore di uscita. I dischi si impilano uno sopra l'altro fino ad un'altezza di 500 mm.

- Machine designed for grinding clutch disks equipped with two heads with abrasive belts, composed of three modules protected by the enclosure accessible through doors with independent sensors and emergency button. Loader and demoulder system with variable speed of ascent, descent and picker controlled by software. Installed in the front of the conveyor belt at the beginning of the working cycle for loading great numbers of disks. The conveyor receives the disks from the load module and feeds them to the workstation. The feeding speed is controlled by a software with inverter. The working station includes 4 rollers that center the disk and makes rotate it while the 2 heads with abrasive belts approach and begin to deburr to 45° above the top edge and bottom of the disk. After processed heads turn away and disk feeds to the staker. End stacker receives number of disks one above the other for max of 500 mm height. When the stacker is full the operator must remove the disks in order to make it receives more.



## Grinding machine for corners 6 heads



watch video



Macchina speciale per la rimozione dei cordoni di saldatura sui bordi di scatole in acciaio. Impianto elettrico separato con PLC per il controllo delle singole teste. Piano di appoggio pezzo regolabile in larghezza per diverse dimensioni dei pezzi.

Quattro teste dotate di pattini posizionate a coppie formando angolo di 90° per la pulitura dei riporti di saldatura sui lati dello spigolo.

Due teste, poste in posizione superiore, con due rulli su cui scorre nastro abrasivo libero e i rulli oscillano sia in angolazione che nel fulcro, regolabili per ottenere il raggio necessario alla pulitura dello spigolo.

Il pezzo in fase di lavoro viene bloccato sul piano e le sei teste con sistema pneumatico di sali scendi si muovono longitudinalmente avvicinandosi al punto da lavorare simultaneamente su entrambi i bordi del pezzo, in primis le teste con i pattini e successivamente quelle con i rulli. Le teste risalgono automaticamente e si riposizionano in situazione iniziale.

Special machine designed for removing welding on edges of metal boxes. Separate electric cabinet with PLC for managing the single heads. Support for pieces adjustable in width for different sizes of the pieces.

Four heads equipped with pads placed at 90° for polishing welding on the sides of the edge

Two heads, situated on top, with two rollers on which slides the free abrasive belt and the rollers oscillate on the edge, adjustables for obtaining the requested radius for polishing the edges.

The pieces are fixed on the table and the heads by pneumatic system approach the point to process simultaneously on both the edges, first the pads and after the rollers, the heads move up and down together.

The heads come up automatically when they finish to process the edges and come on the initial position.





## Grinding machine for sheet metal strips



watch video



🇮🇹 Impianto automatico per la lavorazione di strisce di lamiera con impianto elettrico separato, per la sbavatura dei bordi di pezzi con larghezza da 30 a 450 mm e spessore da 0,5 a 4 mm. La macchina è composta da due teste anteriori con nastri liberi incrociati che permettono di rompere lo spigolo sopra e sotto, e due teste posteriori che lavorano in orizzontale su ruota di contatto direttamente sul bordo del pezzo per assicurarne la satinatura.

L'operatore imposta la larghezza del pezzo da pannello di controllo, le teste scorrono su due guide posizionate sul basamento della macchina. Ogni singola testa è regolabile tramite volantino per assicurare il corretto contatto del nastro con il pezzo. Una serie di rulli con molle permettono l'avanzamento del pezzo.

🇬🇧 Automatic system to process strips of sheet metal with separate electric cabinet, for deburring pieces with width from 30 to 450 mm and thickness from 0,5 to 4 mm.

The machine is equipped with two heads in front with free crossed belts that allow to round the edge top and bottom and two back heads that process horizontally on contact roller directly on the edge to ensure the sanding. The operator set the width by the control panel, the heads slide on two guides fixed on the basement. Each single head is adjustable by handwheel to ensure the correct contact of the belt.



## Grinding machine for poles



watch video

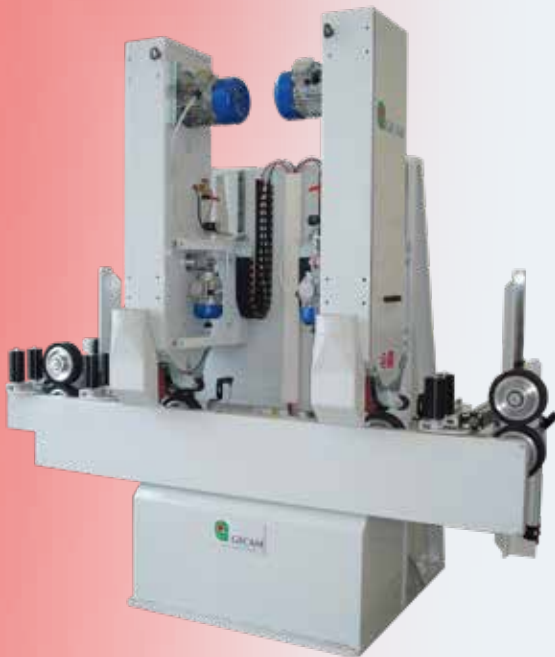

Macchina speciale a due teste abrasive progettata per la rimozione dei cordoni di saldatura di tubi con diametro da 50 a 300.

Doppia testa di pulitura montate su un telaio e regolate in altezza secondo il diametro da lavorare tramite cilindro pneumatico. La macchina è inserita in linea con la macchina di saldatura e collegata all'impianto elettrico della saldatrice per ricevere il segnale di inizio lavorazione.

Smerigliatura con nastro abrasivo su rulli oscillanti con una regolazione che permette di definire la zona di sbavatura e la larghezza dell'area di lavoro.

Sistema di posizionamento verticale del pezzo con sistema manuale e rilevamento della posizione elettronica. La testa operatrice si inserisce e scende sul pezzo al rilevamento dello stesso sui rulli trasportatori. Al termine della lavorazione il palo rimane sulla rulliera fino allo scarico manuale

Special machine with two abrasive belt designed for removing welding on pipes with diameter from 50 to 300.

Double polishing head mounted on a fixed frame, the heads are adjustable in height through pneumatic cylinder. The machine is positioned out of a welding line and it is connected to the electrical cabinet of the welding and receive the signal of starting works by the welding machine.

Grinding by abrasive belt on oscillating rollers with a regulation that allows to define the area to deburr and the width of the working area.

The piece is positioned horizontally on the frame and an electronic sensor find out the presence of the piece. As soon as the sensor detects the piece, the heads starts positioning themselves directly on the workpiece and the rollers move the piece.



## Grinding machine for tubes



- Macchina speciale a nastro abrasivo da inserire in linee per la lavorazione del tubo in acqua, per la rimozione del cordone di saldatura, collegata direttamente all'impianto elettrico della linea.  
Regolazione del diametro dell'apertura per ingresso pezzo tramite volantino.  
Tensione pneumatica del nastro con cilindro.  
Lavorazione ad umido tramite spruzzatori d'acqua posizionati all'interno della macchina direzionati sul punto di lavoro del nastro abrasivo. Lavorazione a nastro libero per adattarsi meglio alla superficie da lavorare.

- Special machine with abrasive belt designed for removing welding from pipes, the machine is suitable to be added in line on the machine for processing tubes, works with water, directly connected with the electrical cabinet of the line.  
Adjustment by handwheel of open for the entrance of piece in function of the diameter.  
Pneumatic tension of the belt with cylinder.  
Wet processing through water sprinklers positioned inside the machine directed on the working point of the abrasive belt. Processing by free belt to better adjust on the surface to process.

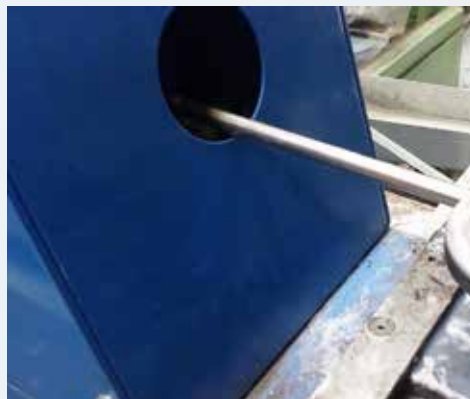

## Grinding machine for boxes



watch video

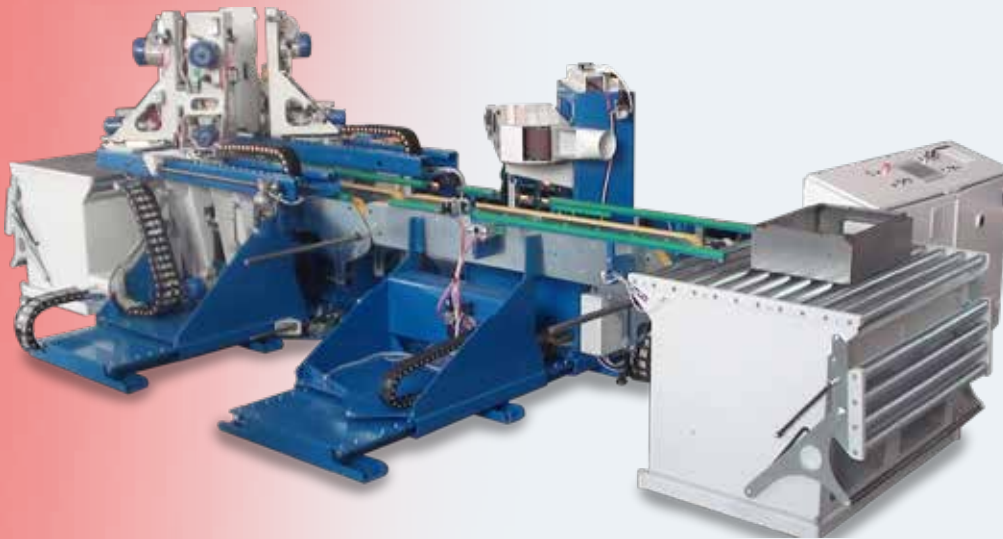

- Macchina speciale per la smerigliatura di bordi e angoli superiori di scatole elettriche, con impianto elettrico e comando PLC separato. Piano di appoggio per entrata ed uscita pezzo.  
Due nastri trasportatori che, comandati da PLC si adattano alla larghezza del pezzo.  
N.1 testa con nastro abrasivo oscillante, con movimento longitudinale per la rimozione della saldatura sul bordo della scatola.  
N.4 teste con nastro abrasivo su pattini per la rimozione delle saldature sui quattro angoli superiori della scatola.

- Special machine for grinding edges and top corner on electrical boxes, with separate electrical panel and PLC.  
Support for in and out of pieces. Two conveyor belt adjustable for the width of the pieces, controlled by PLC.  
N. 1 head with oscillate abrasive belt, with longitudinal movement for removing welding on box edge.  
N. 4 heads with abrasive belts on pads for removing welding on the four upper corners of the box.



## Deburring machine for steel and copper bar



watch video



- Macchina speciale a nastro abrasivo progettata per la pulitura di barre di rame e acciaio, dotata di sei teste operative, tre superiori e tre inferiori per la lavorazione del pezzo su entrambi i lati. Due teste con nastro abrasivo per la rimozione della bava da laser e punzone e quattro teste con spazzola scotch brite per la finitura superficiale. In uscita dalla macchina uno scaricatore automatico spinge i pezzi fuori dal tappeto una volta occupata la superficie utile, un sensore rileva la presenza dei pezzi e indica quando il tappeto non può più riceverne.

Larghezza utile di lavoro fino a 300 mm per uno spessore fino a 50 mm.

Impianto elettrico separato con touch screen per il controllo di tutte le funzioni della macchina.

Filtro di aspirazione delle polveri collegato direttamente alla macchina con capacità di aspirazione fino a 6000 m<sup>3</sup>/h

- Special machine with abrasive belt designed for deburring and finishing copper and steel bar, equipped with 6 operating heads, three top and three bottom for processing piece on both sides. Two heads with abrasive belt for deburring from laser or punching and four heads with scotch brite brushes for surface finishing. At the end of the conveyor belt is connected an automatic unloader that push out the pieces when the conveyor belt is full, a sensor detect the pieces and gives indication if the conveyor is able to receive more or not.

Working width up to 300 mm and thickness up to 50 mm.

Separate electric panel with touch screen for controlling all the function.

Suction system connected directly to the machine that take the powder directly from the working point inside the machine. Suction capacity up to 6000 m<sup>3</sup>/h



## Grinding machine for legs of table



watch video



- Macchina smerigliatrice progettata per la rimozione di saldature sugli angoli di pezzi tubolari a 90°, esempio gambe di tavoli, con lavorazione dei quattro lati dell'angolo in unico ciclo di lavoro. Composta di 4 teste smerigliatrici di cui due verticali speculari che lavorano contemporaneamente il lato superiore ed inferiore dell'angolo e due posizionate in orizzontale per la pulitura dei laterali. Tensione pneumatica dei nastri.

Controllata da PLC touch screen con possibilità di regolazione delle singole teste in maniera indipendente e controllo dei singoli tempi di lavorazione a seconda della finitura richiesta. Movimentazione sull'asse verticale delle teste laterali per sfruttare al meglio l'intera superficie del nastro abrasivo.

- Grinding machine designed for removing welds on corners of tubulars at 90°, like legs of table, processing the four sides of the corner in the same working cycle. Composed of 4 grinding heads of which two positioned on vertical that work at the same time the upper and lower side of the angle and two positioned horizontally for polishing the lateral sides. Pneumatic tension of the belts.

Controlled by PLC touch screen with available adjusting of the single heads independently and control of the single processing times depending on the finishing required. Movement on the vertical axis of the lateral heads to best exploit the entire surface of the abrasive belt.

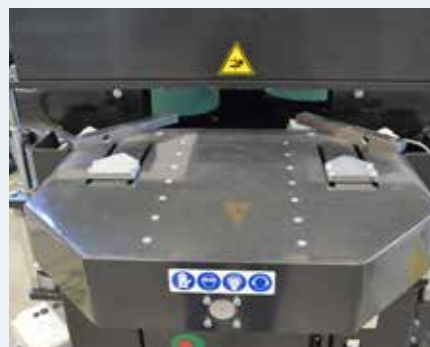

# Automatic deburring system for container frameworks



watch video

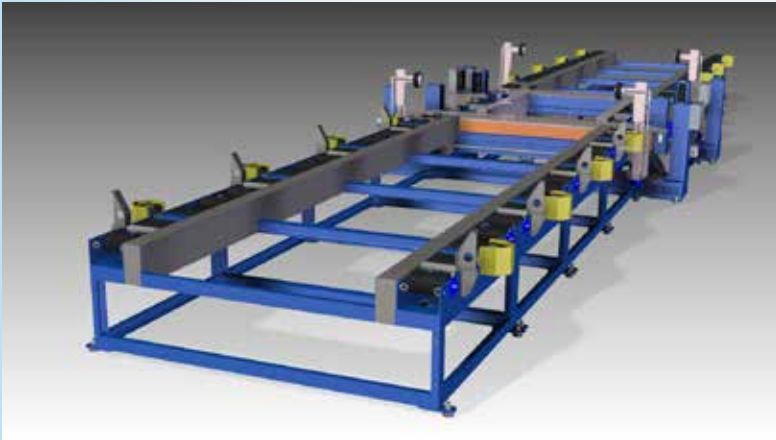

 Complete system for deburring container frameworks composed by feeding system and 4 operating heads.

n. 1 infeed + n. 1 outfeed tables with motorized rollers which move the the frameworks on the X axis, with feeding system speed controlled electronically. The clamping system locks the framework in the different working positions.  
n. 2 lateral operating heads with movement on z axis, stroke of 550 mm equipped with motor 5.5 kW controlled by the inverter (speed from 12 to 30 m/s). Pneumatic tensioning of abrasive belt and pneumatic compensation guide block that allow the correct removal of slag  
n. 2 frontal operating heads with vertical movement, stroke 550 mm equipped with motor 7.5 kW controlled by the inverter (speed from 12 to 30 m/s). Each head has 2 front groups with one pad and one roller, working simultaneously. Pneumatic tensioning of abrasive belt and two pneumatic compensation guide block.  
PLC controller for all parameters, roller and pad pressure, abrasive belt speed, oscillation system, axis speed.  
Cartridge filter for dust extraction, compressed air self-cleaning process, with an absorbed air volume of 6000 m<sup>3</sup>/h equipped with silencer and spark separator.

 Complete system for deburring container frameworks composed by feeding system and 4 operating heads.

n. 1 infeed + n. 1 outfeed tables with motorized rollers which move the the frameworks on the X axis, with feeding system speed controlled electronically. The clamping system locks the framework in the different working positions.  
n. 2 lateral operating heads with movement on z axis, stroke of 550 mm equipped with motor 5.5 kW controlled by the inverter (speed from 12 to 30 m/s). Pneumatic tensioning of abrasive belt and pneumatic compensation guide block that allow the correct removal of slag  
n. 2 frontal operating heads with vertical movement, stroke 550 mm equipped with motor 7.5 kW controlled by the inverter (speed from 12 to 30 m/s). Each head has 2 front groups with one pad and one roller, working simultaneously. Pneumatic tensioning of abrasive belt and two pneumatic compensation guide block.  
PLC controller for all parameters, roller and pad pressure, abrasive belt speed, oscillation system, axis speed.  
Cartridge filter for dust extraction, compressed air self-cleaning process, with an absorbed air volume of 6000 m<sup>3</sup>/h equipped with silencer and spark separator.





## Pick and place for punching machine



watch video



-  Caricatore barre per punzonatrice Cu Profi Boschert con sistema di presa pneumatico, idoneo per barre fino a 4200 mm di lunghezza, inserita in linea con la punzonatrice stessa. Quadro elettrico indipendente interfacciato direttamente con i comandi della punzonatrice, con touch screen che permette il pieno controllo delle due macchine simultaneo.
-  Special machine for loading pieces on Boschert punching machine CU Profi, with pneumatic picking system through suckers, suitable for bars up to 4200 mm length, in line with the punching machine. Complete of independent electric cabinet with touch screen, that is directly connected with the punching machine guaranting a simultaneously control of both the punching and the picking machine.





## Special project

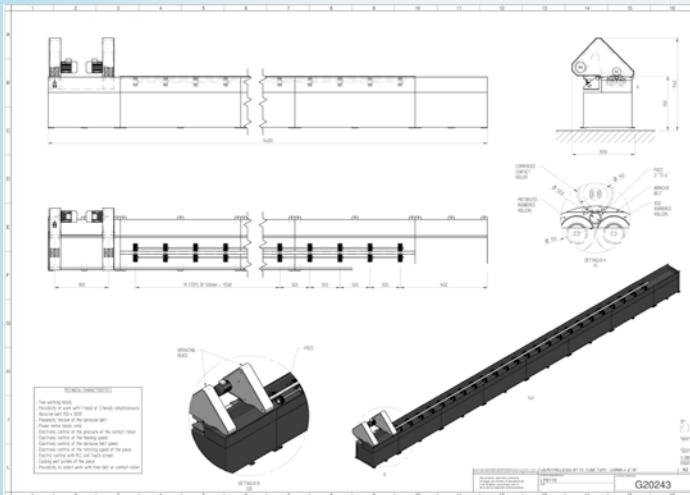

Impianto centreless tubi lunghezza 12 m con diametro da 2 a 6 mm. Due teste operatrici a nastro abrasivo che possono lavorare insieme o singolarmente. Controllo elettronico con PLC e touch screen, sistema ad umido per il raffreddamento del pezzo durante la lavorazione

Centreless system for tubes length 12m with diameter from 2 to 6 mm. Two working heads with abrasive belt, suitable to process simultaneously or independent. Electronic control by PLC and touch screen, cooling wet system of the piece during processing.

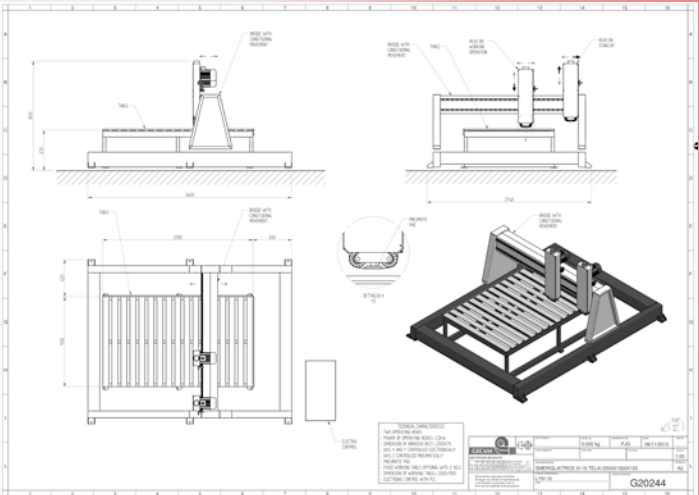

Smerigliatrice telai con due teste operatrici a nastro abrasivo, a tre assi. Asse X e Y controllate elettronicamente e asse Z controllata pneumaticamente. Piano di lavoro fisso, le teste si muovono lungo il piano e lavorano con pattino. Impianto controllato tramite PLC.

Grinding frames with two operating heads with abrasive belt at three axis. Axis X and Y controlled electronically and axis Z controlled pneumatically. Fixed working support, the heads move along the piece and process with pads. The machine is controlled by PLC.

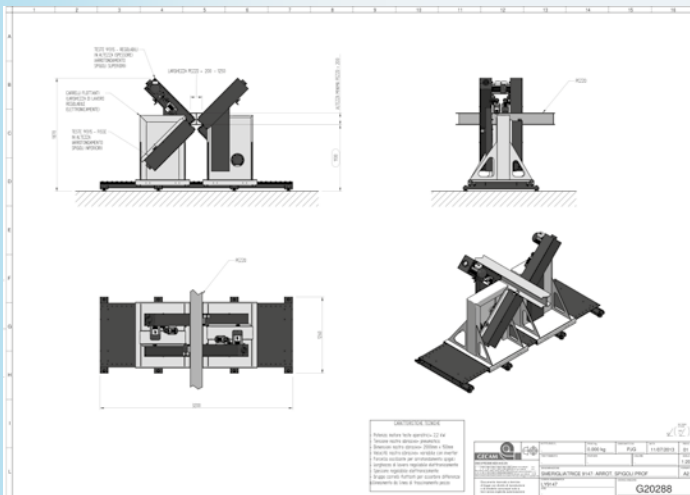

Smerigliatrice a quattro teste per l'arrotondamento di spigoli di profilati, a nastro abrasivo con tensione pneumatica. Teste con forcella oscillante per movimento solo sullo spigolo, larghezza e spessore di lavoro regolabile elettronicamente, con velocità variabile del nastro. Gruppo carrelli flottanti per assorbimento delle differenze di allineamento.

Grinding machine with four heads for rounding edges of bars, at abrasive belt with pneumatic tension. Heads with oscillating fork that moves only on the edge, width and working thickness adjustable electronically, with variable speed of the belt. Carriage group floating for absorption of differences in alignment.

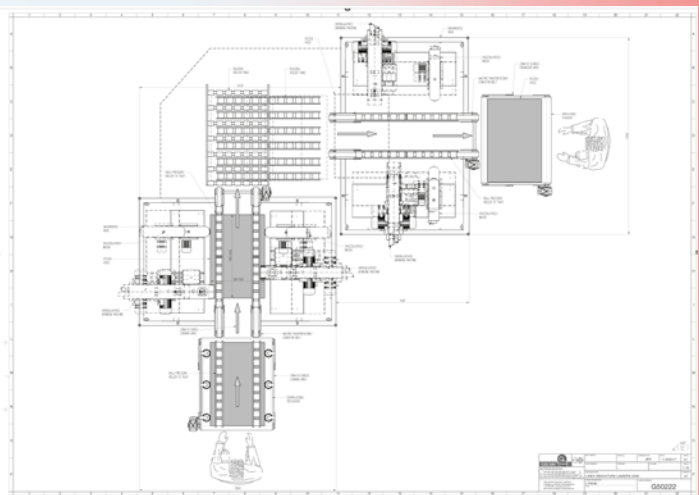

Linea di sbavatura di fogli di lamiera con zona di carico con deimpilatore e due zone di lavoro, composte rispettivamente da n. 2 teste smerigliatrici e n. 2 teste spazzolatrici, che permettono di lavorare tutti i 4 lati del foglio. Tra le due zone, una rulliera prende il pezzo dopo la prima lavorazione e lo fa scorrere nella seconda zona per la lavorazione degli altri due lati del foglio.

Deburring line for sheet metal with loading zone and two working areas, both composed of two grinding heads and two brushing, that allow to process all the side of the sheet. Between the two working areas, a roller table take the piece processed and moves it to the second processing area for the last two sides of the sheet.

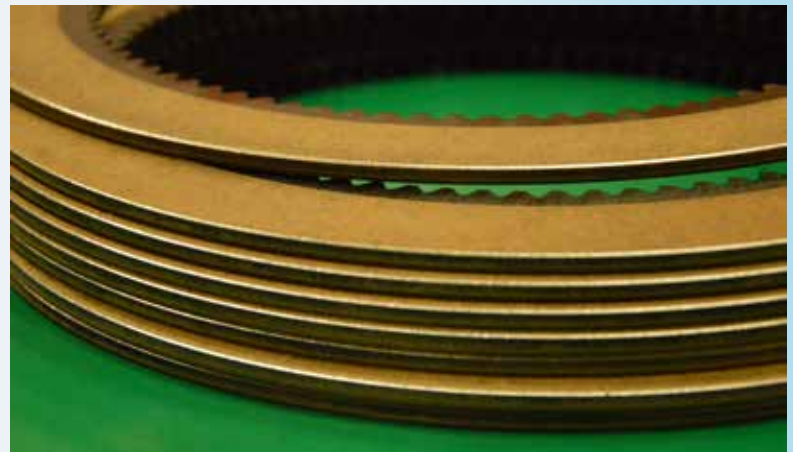

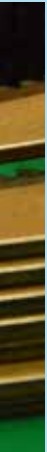

**Vertrauen Sie auf über 70 Jahre Erfahrung!**

Die Firma HESSE+CO wurde 1947 als Hersteller von Blechbearbeitungsmaschinen gegründet. Seit 1980 sind wir auf den Handel mit neuen sowie gebrauchten Blechbearbeitungs- und Werkzeugmaschinen spezialisiert. Wir haben ständig etwa 300 Maschinen in unserer 2.000 m<sup>2</sup> großen Ausstellungshalle, die nur 20 Minuten vom internationalen Flughafen Wien entfernt ist.

**Trust in more than 70 years of experience!**

HESSE+CO was established in 1947 as a manufacturer of sheet metal working machines. Since 1980 we are specialized in dealing with new and second hand sheet metal processing machines and machine tools. We always have approximately 300 machines available in our 2.000 m<sup>2</sup> showroom, which is located only 20 minutes from the Vienna International Airport, waiting for your inspection.

**[www.hesse-maschinen.com](http://www.hesse-maschinen.com)**

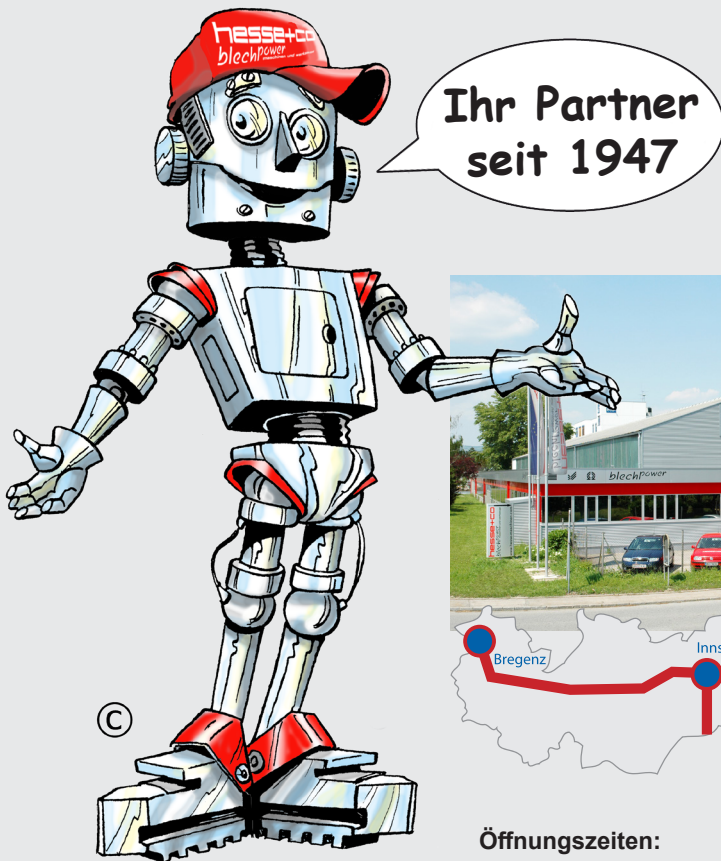

**Öffnungszeiten:**

Mo - Do 8:00 - 16:30 Uhr  
Fr 8:00 - 14:30 Uhr

HESSE+CO Maschinenfabrik GmbH  
Industriezentrum NÖ-Süd  
Straße 4 - Objekt 8  
A-2351 Wiener Neudorf  
AUSTRIA



Technische Änderungen, Irrtum und Druckfehler vorbehalten.  
Gültig bis auf Widerruf.

Tel.: +43/2236/638 70-0  
Fax: +43/2236/636 62  
[office@hesse-maschinen.com](mailto:office@hesse-maschinen.com)  
[www.hesse-maschinen.com](http://www.hesse-maschinen.com)  
[www.blechpower.com](http://www.blechpower.com)