

hesse

hesse+co
blechpower
maschinen und werkzeuge

STEMPEL UND MATRIZEN

Original **GEKA**  Made in EU



Ihr Partner seit 1947

www.hesse-maschinen.com

Inhalt

Preis- und Lieferbedingungen	3
Wichtige Hinweise zu GEKA Stanzwerkzeugen	4
Schnittspalt zwischen Stempel und Matrize	5
Benötigte Stanzkraft	6
Auswahl des passenden Werkzeugtypes	7
Preise für GEKA - Stempel	8
Preise für GEKA - Matrizen	9
Preise für Radius- und Spezialstempel und Matrizen	10
Preise für Zylinderschloßwerkzeuge und Paßfedern	11
Standardgrößen Rundlochstempel und Matrizen bis 27,5 mm	12
Standardgrößen Rundlochstempel und Matrizen bis 100 mm	13
Standardgrößen Langloch- und Offsetstempel und Matrizen	14
Standardgrößen Quadrat- und Rechteckstempel und Matrizen	15



Mod. Bendicrop mit fixem Winkelbieger

Preis- und Lieferbedingungen

Die Preise verstehen sich ab Lager Wr. Neudorf
zzgl. Verpackungskostenpauschale von € 4,00
zzgl. gesetzlicher Mwst!

- unter einem Nettomaterialwert von € 100,00 verrechnen wir € 25,00 Mindermengenzuschlag
- Ab einem Bestellwert von € 800,00 liefern wir inkl. Verpackung frei Haus!
(gilt nur innerhalb Österreichs, ausgenommen Spezial und Sonderwerkzeuge)
- Ab einem Bestellwert von € 1.000,00 gewähren wir 10% Mengenrabatt!
- Auf Anfrage liefern wir gerne nach Ihren Zeichnungen Sonderwerkzeuge!
- Lieferzeit: Standardgrößen prompt
Sondergrößen ca. 14 Tage
Spezial- oder Sonderanfertigungen nach Anfrage

Alle bisher gültigen Preise und Rabatte verlieren mit diesem Preiskatalog ihre Gültigkeit.

Es gelten ausschließlich die „Allgemeinen Lieferbedingungen des Fachverbandes der Maschinen- und Stahlbauindustrie Österreichs vom 01.01.2002“. Wir verkaufen ausschließlich unter Eigentumsvorbehalt, die Ware bleibt bis zur vollständigen Bezahlung unser uneingeschränktes Eigentum. Gerichtsstand ist Wien!

Irrtum und Druckfehler vorbehalten!

Gültig ab 1. September 2023



Mod. Bendicrop 60 SD mit CNC
Positioniersystem Semipaxy und
B&R 15" Touch-Screen Steuerung

Wichtige Hinweise zu GEKA Stanzwerkzeugen (diese Werte beziehen sich auf eine Materialfestigkeit von ca. 450 N/mm²)

Standardmäßig maximale Stanzdurchmesser:

Maschinentyp	größter Lochdurchmesser	max. Materialstärke
Microcrop	27 mm	10 mm
Minicrop	27 mm	13 mm
Multicrop	27 mm	13 mm
Bendicrop	31 mm	11 mm
Hyd 50 / Puma 50	27 mm	13 mm / 14 mm
Hyd 70 / Puma 70	27 mm	20 mm / 20 mm
Hyd 100 / Puma 100	31 mm / 30 mm	26 mm / 26 mm
Hyd 150 / Puma 150	40 mm / 40 mm	28 mm / 30 mm
Hyd 55 / Puma 55	40 mm / 40 mm	10 mm / 10 mm
Hyd 80 / Puma 80	40 mm / 40 mm	14 mm / 14 mm
Hyd 110 / Puma 110	40 mm / 40 mm	20 mm / 20 mm
Hyd 165 / Puma 165	40 mm / 40 mm	30 mm / 30 mm
Hyd 220 / Puma 220	40 mm / 40 mm	40 mm / 40 mm
IW 45 / IW 45 M	27 mm / 27 mm	13 mm / 13 mm
IW 55 / P 55	40 mm / 40 mm	10 mm / 10 mm
IW 80 / P 80	40 mm / 40 mm	14 mm / 14 mm
IW 110 / P 110	40 mm / 40 mm	20 mm / 20 mm

Für nicht kreisrunde Formen gilt:
Die zu stanzende Kontur muss vom maximal stanzbaren Durchmesser
umschlossen werden können

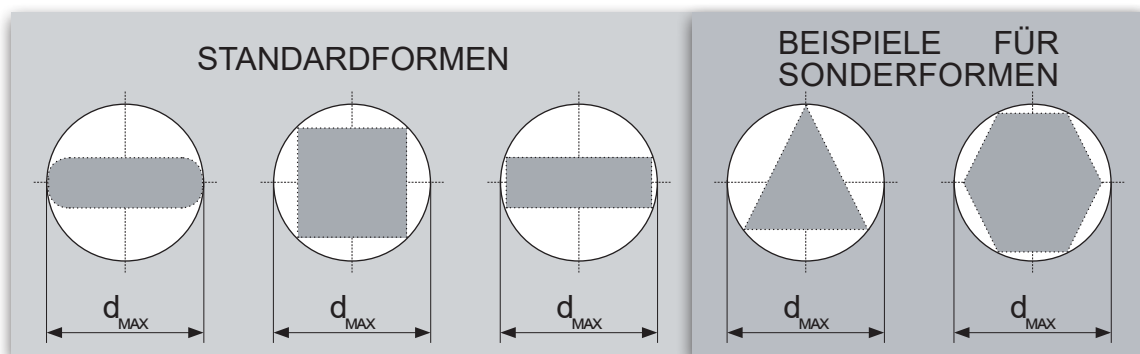

Für größere Lochdurchmesser können GEKA-Maschinen auf Wunsch (auch nachträglich) wie folgt ausgestattet werden:

Lochstanzvorrichtung für große Durchmesser:

- bis 100mm Preis je Maschinentyp auf Anfrage
- bis 160mm Preis je Maschinentyp auf Anfrage

Bitte fragen Sie uns, wir bieten Ihnen gerne die entsprechende Vorrichtung für
Ihre Maschine unverbindlich an!

Schnittspalt zwischen Stempel und Matrize

Üblicherweise gilt die alte und bewährte Regel von 10% der Materialstärke.

Sollten Sie keinen speziellen Schnittspalt angeben, dann liefern wir Ihre Matrizen mit 0,7mm Schnittspalt aus!

Wünschen Sie eine genauere Ermittlung des Schnittspaltes, dann nehmen Sie bitte untenstehende Schnittlufttabelle zu Hilfe.

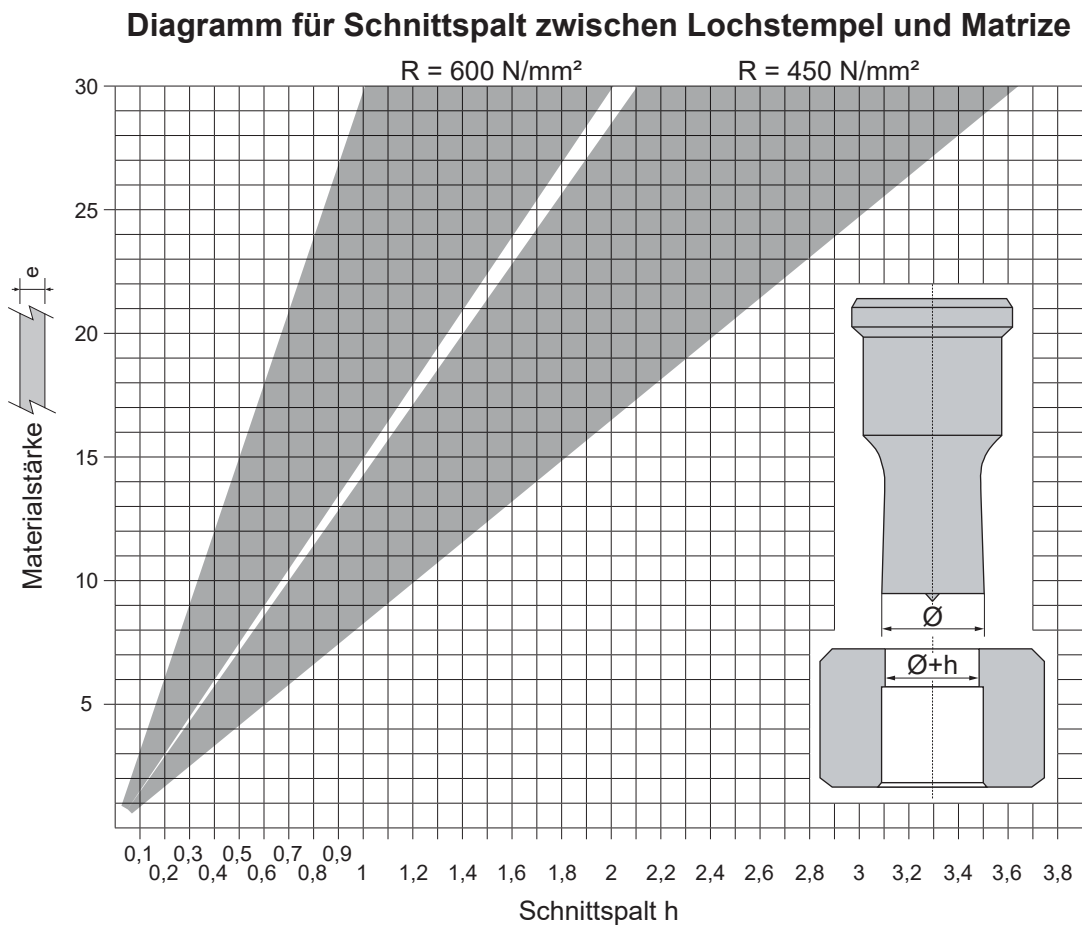

Benötigte Stanzkraft

Bitte verwenden Sie folgende Tabelle zur Ermittlung der benötigten Stanzkraft:

Stanzkraft in kN bei Rundlöchern

Ø	BLECHDICKEN (420 – 480 N/mm ²)														
	0,6	0,8	1,0	1,2	1,5	2,0	2,5	3,0	3,5	4,0	5,0	6,0	7,0	8,0	10,0
2	1,8	2,3	2,9	3,5	4,4	5,8									
4	3,5	4,7	5,8	7,0	8,7	11,5	14,5	17,5	20,0	23,0	29,0	35,0			
6	5,2	7,0	8,7	10,5	13,0	17,5	22,0	26,0	30,0	35,0	44,0	52,0	61,0		
8	7,0	9,3	11,5	14,0	17,5	23,0	29,0	35,0	40,0	46,0	58,0	70,0	81,0	93,0	
10	8,7	11,5	14,5	17,5	22,0	29,0	36,0	44,0	50,0	58,0	72,0	87,0	101,0	115,0	145,0
12	10,4	14,0	17,5	21,0	26,0	35,0	44,0	52,0	60,0	70,0	88,0	104,0	122,0	140,0	175,0
14	12,2	16,0	20,0	24,5	30,0	40,0	51,0	60,0	70,0	80,0	102,0	122,0	142,0	160,0	200,0
16	14,0	18,5	23,0	28,0	35,0	46,0	58,0	70,0	80,0	92,0	116,0	140,0	162,0	185,0	230,0
18	15,7	21,0	26,0	32,0	39,0	52,0	65,0	78,0	90,0	104,0	130,0	157,0	182,0	210,0	260,0
20	17,5	23,0	29,0	35,0	43,0	58,0	73,0	86,0	100,0	116,0	146,0	175,0	202,0	230,0	290,0
25	22,0	29,0	36,0	44,0	55,0	72,0	91,0	110,0	125,0	144,0	182,0	220,0	255,0	290,0	360,0
30	26,0	35,0	43,0	52,0	65,0	86,0	110,0	130,0	150,0	172,0	220,0	260,0	305,0	350,0	430,0
35	30,0	40,0	50,0	60,0	76,0	100,0	127,0	150,0	180,0	200,0	254,0	300,0	355,0	400,0	500,0
40	35,0	47,0	58,0	70,0	87,0	115,0	145,0	175,0	200,0	230,0	290,0	350,0	405,0	470,0	580,0
45	39,0	52,0	65,0	78,0	98,0	130,0	165,0	195,0	230,0	260,0	330,0	390,0	455,0	520,0	650,0
50	44,0	58,0	72,0	88,0	110,0	145,0	180,0	220,0	250,0	290,0	360,0	440,0	510,0	580,0	720,0
60	52,0	70,0	87,0	104,0	130,0	175,0	220,0	260,0	300,0	350,0	440,0	520,0	610,0	700,0	870,0
70	61,0	81,0	100,0	125,0	150,0	200,0	250,0	300,0	350,0	400,0	500,0	610,0	710,0	810,0	1000,0
80	70,0	93,0	115,0	140,0	175,0	230,0	290,0	350,0	400,0	460,0	580,0	700,0	810,0	930,0	1150,0
100	87,0	115,0	145,0	175,0	220,0	290,0	360,0	440,0	510,0	580,0	720,0	870,0	1020,0	1150,0	1450,0

Sollten Sie in der Tabelle keinen passenden Wert, finden verwenden Sie bitte folgende Berechnungsformel:

$$\text{STANZKRAFT (kN)} = \frac{\text{Blechdicke (mm)} \times \text{Lochumfang (mm)} \times \text{Zugfestigkeit (N/mm}^2\text{)}}{1000}$$

Beispiel:

Material ist ein Schwarzblech mit 380 N/mm² Zugfestigkeit und 10 mm Dicke, zu stanzen ist ein Rundloch mit 40 mm Durchmesser:

$$\text{LOCHUMFANG} = \text{Durchmesser} \times \text{Pi} = 40 \text{ mm} \times 3,14 = 125,6 \text{ mm}$$

$$\text{STANZKRAFT} = \frac{10 \text{ mm} \times 125,6 \text{ mm} \times 380 \text{ N/mm}^2}{1000} = 477,28 \text{ kN (48,67 to)}$$

Auswahl des passenden Werkzeugtypes

Diese Tabelle soll Ihnen eine kleine Hilfe geben!



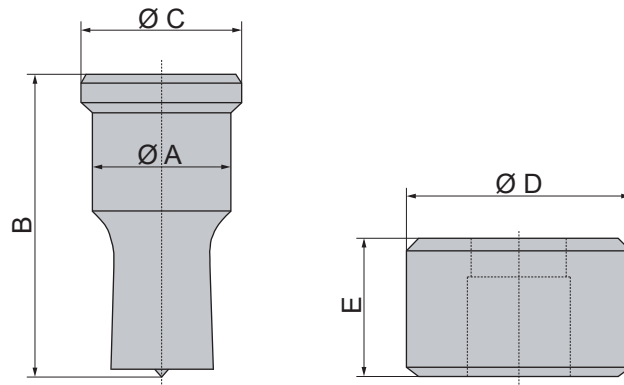

Bitte geben Sie bei jeder Bestellung Ihren Maschinentyp an, wir können Ihnen dann automatisch den richtigen Stempel und Matrizen typ zuzenden!



MOD.	Nr.		A	B	C	Nr.	D	E
MICROCROP MINICROP-MULTICROP HYD-50-70 P.P.50, PUMA-50-70 IW-45-45M	5-27	■	27	53	30,5	5	50,8	25,5
BENDICROP 50	8-31	■	31	64	35	5	50,8	25,5
BENDICROP 60-85 HYD-55-80 PUMA-55-80 IW-55-80	8-31	■ ■	31	64	35	8	60	32
	8-40	■ ■	40		43,5			
HYD-100 PUMA-100	8-31	■ ■	31		35			
HYD-110 PUMA-110 IW 110	8-31	■ ■	31	35	10	73		
	8-40	■ ■	40	43,5				
HYD-150-200 PUMA-150-200	10-26	■ ■	26	73			29,5	
	10-40	■ ■	40				43,5	
MINICROP-MULTICROP HYD-50-70-100 PUMA-50-70-100 HYD-55-80-110 PUMA-55-80-110	Ø 100	11	■ ■	50	58	54	11	78
		12	■ ■	75		79	12	100
		13	■ ■	100		104	13	125
HYD-150-200 PUMA-150-200	Ø 100	11A	■ ■	50	73	54	11	78
		12A	■ ■	75		79	12	100
		13A	■ ■	100		104	13	125

- Standard für Resteuropa
- Standard für Spanien





Preise für GEKA - Stempel

Stempel Type	 Rundloch		 Langloch		 Quadrat und Rechteck		 Rund- exzentrisch	
	Größen	Preis [€]	Größen	Preis [€]	Größen	Preis [€]	Größen	Preis [€]
5-27 Standard	Ø 5 - 22,0 1,0 mm Schritte	12,00	7x15 9x19 11x23 13x27 15x27 17x26 19x26	36,00	4/5/6/7/8/9/10/ 11/12/13/14/15/ 16/17/18/19/20 7x10/15 9x13/19 11x17/23 13x19/25 15x21	36,00	5/6/7/8/9/10/11/ 12/13/14	49,00
5-27 nicht Standard	max. Ø 27	54,00	max. A x 27	75,00	max. 20x20	77,00	max. 17	75,00
8-31 Standard	Ø 4 - 31,0 0,5 mm Schritte	17,00	7x10/15/20 9x13/19/25 11x17/23 13x18/22/27/31 15x20/24/27/31 17x22/26/31 19x26/31 21x27/31	42,00	6/7/8/9/10/ 11/12/13/20 7x10/15 9x13/19 11x17/23 13x19/25 15x21/27 17x25	42,00	5/6/7/8/9/10/11/ 12/13/14/15/16/ 17/18	58,00
8-31 nicht Standard	max. Ø 31	54,00	max. A x 31	80,00	max. 21x21	83,00	max. 21	80,00
8-40 Standard	Ø 32 - 40 1,0 mm Schritte	29,00	17x40 19x40 21x40	61,00	24/26/28 20x34	61,00	6/7/10/14	73,00
8-40 nicht Standard	max. Ø 40	72,00	max. A x 40	80,00	max. 28x28	95,00	max. 30	80,00
10-26 Standard	Ø 6 - 20 0,5 mm Schritte	18,00	7x10/15/20 9x13/19/25 11x17/23 13x18/22 15x20	43,00	4/5/6/7/8/9/10/ 11/12/13/14/15 7x10/15 9x13/19 11x17/23 13x19	43,00	-	-
10-26 nicht Standard	max. Ø 26	54,00	max. A x 26	82,00	max. 15x15	87,00	max. 15	82,00
10-40 Standard	Ø 20,5 - 30,5 0,5 mm Schritte Ø 31 - 34 1,0 mm Schritte	30,00	9x25 11x23 13x22/27/31 15x24/27/31 17x22/26/31/40 19x26/31/40 21x27/31/40	66,00	21 11x23 13x19/25 15x21/27 17x25 19x30 20x34	66,00	5/6/7/8/9/10/11/ 12/13/14/15/16/17/ 18/19/20/21/22/ 23/24/25	86,00
10-40 nicht Standard	max. Ø 40	72,00	max. A x 40	92,00	max. 28x28	92,00	max. 30	92,00
11 Standard	Ø 41 - 50 1,0 mm Schritte	63,00	15x31 17x31/40 19x31/40 21x31/40 25x45/50	104,00	31/35 17x25 19x30 20x34 25x43	110,00		
11 nicht Standard	max. Ø 50	67,00	max. A x 50	112,00	max. 40x40	142,00		
12 Standard	Ø 52 - 74 2,0 mm Schritte	98,00	27x63	167,00	40/44/48/53 25x70	192,00		
12 nicht Standard	max. Ø 75	106,00	max. A x 75	192,00	max. 53x53	205,00		
13 Standard	Ø 76 - 90 2,0 mm Schritte	126,00	30x100	194,00	70 25x96	206,00		
13 nicht Standard	max. Ø 100	137,00	max. A x 100	206,00	max. 70x70	222,00		
14 Standard	Ø 100-120 auf Anfrage	auf Anfrage	auf Anfrage	auf Anfrage	auf Anfrage	auf Anfrage		
15 Standard	Ø 120-160 auf Anfrage	auf Anfrage	auf Anfrage	auf Anfrage	auf Anfrage	auf Anfrage		

Alle Maße in mm. Weitere Größen und Formen auf Anfrage.

alle Preise in € exkl. 20 % MwSt.

Preise für GEKA - Matrizen

Matrize Type	 Rundloch		 Langloch		 Quadrat und Rechteck		 Rund-exzentrisch	
	Größen	Preis [€]	Größen	Preis [€]	Größen	Preis [€]	Größen	Preis [€]
5 Standard	Ø 4 - 31 0,5 mm Schritte Schnittspalt 0,2 oder 0,7 Ø 32,7	15,00	7x10/15/20 9x13/19/25 11x17/23 13x18/22/27 15x20/24/27 17x22/26 19x26 19x31 Schnittspalt 0,7	39,00	6/7/8/9/10/11/20 Schnittspalt 0,7 9x19 Schnittspalt 0,7	65,00	5/6/7/8/9/10/11/ 12/13/14/15/16/ 17/18 Schnittspalt 0,7	42,00
5 nicht Standard	max. Ø 32	55,00	max. A x 31	76,00	max. 22	102,00	max. 18	80,00
8 Standard	Ø 33 - 40 1,0 mm Schritte Schnittspalt 0,7	30,00	17x40 19x40 Schnittspalt 0,7	55,00	4/5/6/7/8/9/10/11/ 12/13/14/15/16/1 7/18/19/20/21/22 /24/26/28 Schnittspalt 0,7 7x10/15 9x13/19 11x17/23 13x19/25 15x21/27 17x25 19x30 20x34 Schnittspalt 0,7	70,00	10/11/12/13/14 Schnittspalt 0,7	60,00
8 nicht Standard	max. Ø 40	70,00	max. A x 40	97,00	max. 28	108,00	max. 21	98,00
10 Standard	Ø 18 - 31 0,5 mm Schritte Schnittspalt 0,2 oder 0,7 Ø 32 - 40 1,0 mm Schritte Schnittspalt 0,7	57,00	13x27/31 15x20/24/27/31 17x22/26/31/40 19x40 21x40 Schnittspalt 0,7	91,00	28 Schnittspalt 0,7 7x10/15 9x13/19 11x17/23 13x19/25 15x21/27 17x25 19x30 20x34 Schnittspalt 0,7	120,00	11/12/13/14/15 Schnittspalt 0,7	91,00
10 nicht Standard	max. Ø 40	98,00	max. A x 40	132,00	max. 28	158,00	max. 21	129,00
11 Standard	Ø 41 - 50 1,0 mm Schritte Schnittspalt 0,5	132,00	13x31 15x20/24/27/31 17x22/26/31/40 19x26/31/40 21x27/31/40 Schnittspalt 0,7 25x45/50 Schnittspalt 0,5	132,00	31/35 Schnittspalt 0,5 17x25 19x30 20x34 Schnittspalt 0,7 25x43 Schnittspalt 0,5	132,00		
11 nicht Standard	max. Ø 50	168,00	max. A x 50	168,00	max. 35	168,00		
12 Standard	Ø 52/54/60/62/ 70/72/74 Schnittspalt 0,5	174,00	27x63 Schnittspalt 0,5	174,00	40 Schnittspalt 0,5 25x70 Schnittspalt 0,5	174,00		
12 nicht Standard	max. Ø 75	211,00	max. A x 75	211,00	max. 53	211,00		
13 Standard	Ø 76 / 80 / 90 Schnittspalt 0,5	199,00	30x87/100 Schnittspalt 0,5	199,00	70 Schnittspalt 0,5 25x96 Schnittspalt 0,5	199,00		
13 nicht Standard	max. Ø 100	236,00	max. A x 100	auf Anfrage	max. 70	auf Anfrage		
14 Standard	Ø 100 - 120 auf Anfrage Schnittspalt 0,5	auf Anfrage	auf Anfrage Schnittspalt 0,5	auf Anfrage	auf Anfrage Schnittspalt 0,5	auf Anfrage		
14 nicht Standard	max. Ø 120	auf Anfrage	max. A x 120	auf Anfrage	max. 84	auf Anfrage		
15 Standard	Ø 120 - 160 auf Anfrage Schnittspalt 0,5	auf Anfrage	auf Anfrage Schnittspalt 0,5	auf Anfrage	auf Anfrage Schnittspalt 0,5	auf Anfrage		
15 nicht Standard	max. Ø 160	auf Anfrage	max. A x 160	auf Anfrage	max. 113	auf Anfrage		

Alle Maße in mm. Weitere Größen und Formen auf Anfrage.

alle Preise in € exkl. 20 % Mwst.

Preise für Radius- und Spezialstempel und Matrizen

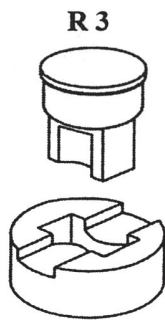

TYPE	max. Flachstahl / Radius	
5 - 27	20 x 6 / 20	20 x 8 / 24
8/31	20 x 6 / 15	20 x 8 / 20
8/40	30 x 8 / 25	30 x 10 / 26
10/40	30 x 8 / 25	30 x 10 / 26
11	40 x 8 / 35	40 x 10 / 40
12	50 x 10 / 30	60 x 12 / 45
13	70 x 12 / 42	80 x 12 / 60

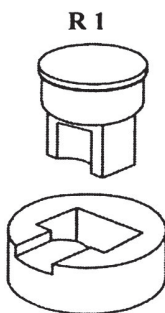

TYPE	max. Flachstahl / Radius	
5 - 27	20 x 6 / 15	20 x 10 / 20
8/31	20 x 8 / 15	25 x 8 / 25
8/40	30 x 8 / 20	30 x 10 / 30
10/40	30 x 8 / 20	30 x 10 / 30
11	40 x 10 / 30	40 x 12 / 40
12	50 x 10 / 30	60 x 14 / 45
13	70 x 12 / 40	80 x 14 / 60

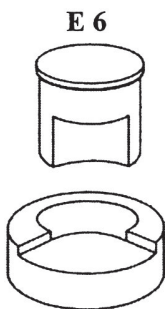

TYPE	max. Radius
5 - 27	17,5
8/31	20
8/40	26
10/40	26
11	32
12	48
13	65

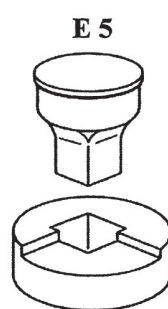

TYPE	max. □
5 - 27	19
8/31	21
8/40	28
10/40	28
11	35
12	53
13	70

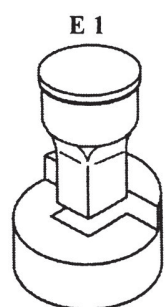

TYPE	max. □
5 - 27	5 x 27 / 24 x 14
8/31	5 x 30 / 24 x 18
8/40	5 x 39 / 30 x 25
10/40	5 x 39 / 30 x 25
11	5 x 49 / 40 x 29
12	5 x 74 / 60 x 42
13	5 x 99 / 80 x 58

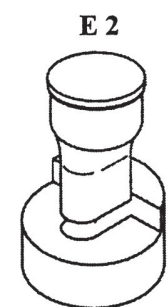

TYPE	max. ⤴
5 - 27	5 x 27 / 24 x 21
8/31	5 x 30 / 24 x 25
8/40	5 x 39 / 30 x 33
10/40	5 x 39 / 30 x 33
11	5 x 49 / 40 x 40
12	5 x 74 / 60 x 60
13	5 x 99 / 80 x 80

TYPE	STEMPEL	TYPE	MATRIZE	SET
6	auf Anfrage	6	auf Anfrage	auf Anfrage
5/27	auf Anfrage	5	auf Anfrage	auf Anfrage
8/31	auf Anfrage	5	auf Anfrage	auf Anfrage
8/40	auf Anfrage	8	auf Anfrage	auf Anfrage
10/40	auf Anfrage	10	auf Anfrage	auf Anfrage
11	auf Anfrage	11	auf Anfrage	auf Anfrage
12	auf Anfrage	12	auf Anfrage	auf Anfrage
13	auf Anfrage	13	auf Anfrage	auf Anfrage

alle Preise in € exkl. 20 % MwSt.

Preise für Zylinderschloßstempel und Matrizen

Stempel Nr.	Matrizen Nr.	Preis [€]
8 - 40	8	375,00

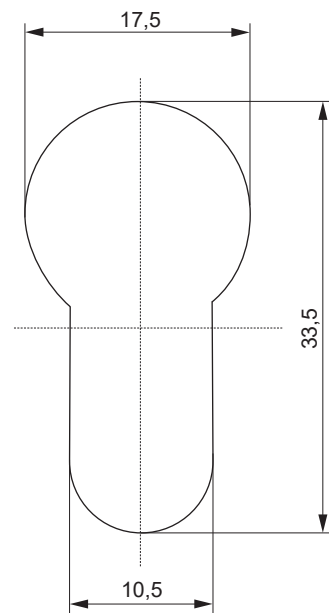



Die Preise gelten für jeweils ein Set, bestehend aus Stempel und dazugehöriger Matrize.

Preise für Passfedern

TYPE	PREIS [€]
jede Größe bis Typ 8-40	3,90

alle Preise in € exkl. 20 % Mwst.

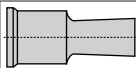

Standardgrößen Rundlochstempel und Matrizen bis 27,5 mm



										Tm./mm
	5/27	6	8/31	10/26	10/40		5	6	8	
						3,2				0,4
3						3,7				0,4
3,5						4,2				0,5
4						4,7				0,5
4,5						5,2				0,6
5						5,7				0,7
5,5						6,2				0,7
6						6,7				0,8
6,5						7,2				0,9
7						7,7				0,9
7,5						8,2				1,0
8						8,7				1,1
8,5						9,2				1,1
9						9,7				1,2
9,5						10,2				1,3
10						10,7				1,3
10,5						11,2				1,4
11						11,7				1,5
11,5						12,2				1,5
12						12,7				1,6
12,5						13,2				1,7
13						13,7				1,7
13,5						14,2				1,8
14						14,7				1,9
14,5						15,2				1,9
15						15,7				2,0
15,5						16,2				2,1
16						16,7				2,1
16,5						17,2				2,2
17						17,7				2,3
17,5						18,2				2,3
18						18,7				2,4
18,5						19,2				2,5
19						19,7				2,5
19,5						20,2				2,6
20						20,7				2,7
20,5						21,2				2,7
21						21,7				2,8
21,5						22,2				2,9
22						22,7				2,9
22,5						23,2				3,0
23						23,7				3,1
23,5						24,2				3,1
24						24,7				3,2
24,5						25,2				3,2
25						25,7				3,3
25,5						26,2				3,4
26						26,7				3,4
26,5						27,2				3,5
27						27,7				3,6
27,5						28,2				3,6

Standardgrößen Rundlochstempel und Matrizen bis 100 mm

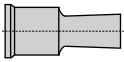
												TYP							Tm./mm
	8/31	8/40	10/40	11	11A	12	12A	13	13A	5		6	8	10	11	12	13		
28																	28,7	3,7	
28,5																	29,2	3,8	
29																	29,7	3,8	
29,5																	30,2	3,9	
30																	30,7	4,0	
30,5																	31,2	4,0	
31																	31,7	4,1	
31,5																	32,2	4,2	
32,0																	32,7	4,2	
32,5																	33,2	4,3	
33,0																	33,7	4,4	
33,5																	34,2	4,4	
34,0																	34,7	4,5	
34,5																	35,2	4,5	
35,0																	35,7	4,6	
35,5																	36,2	4,7	
36,0																	36,7	4,7	
36,5																	37,2	4,8	
37,0																	37,7	4,9	
37,5																	38,2	4,9	
38,0																	38,7	5,0	
38,5																	39,2	5,1	
39,0																	39,7	5,1	
39,5																	40,2	5,2	
40,0																	40,7	5,3	
41,0																	41,5	5,4	
42,0																	42,5	5,5	
43,0																	43,5	5,7	
44,0																	44,5	5,8	
45,0																	45,5	5,9	
46,0																	46,5	6,1	
47,0																	47,5	6,2	
48,0																	48,5	6,3	
49,0																	49,5	6,5	
50,0																	50,5	6,6	
51,0																	51,5	6,7	
52,0																	52,5	6,9	
53,0																	53,5	7,0	
54,0																	54,5	7,1	
55,0																	55,5	7,3	
56,0																	56,5	7,4	
57,0																	57,5	7,5	
58,0																	58,5	7,6	
59,0																	59,5	7,8	
60,0																	60,5	7,9	
61,0																	61,5	8,0	
62,0																	62,5	8,2	
63,0																	63,5	8,3	
64,0																	64,5	8,4	
65,0																	65,5	8,6	
66,0																	66,5	8,7	
67,0																	67,5	8,8	
68,0																	68,5	9,0	
69,0																	69,5	9,1	
70,0																	70,5	9,2	
71,0																	71,5	9,4	
72,0																	72,5	9,5	
73,0																	73,5	9,6	
74,0																	74,5	9,8	
75,0																	75,5	9,9	
76,0																	76,5	10,0	
77,0																	77,5	10,2	
78,0																	78,5	10,3	
79,0																	79,5	10,4	
80,0																	80,5	10,6	
81,0																	81,5	10,7	
82,0																	82,5	10,8	
83,0																	83,5	10,9	
84,0																	84,5	11,1	
85,0																	85,5	11,2	
86,0																	86,5	11,3	
87,0																	87,5	11,5	
88,0																	88,5	11,6	
89,0																	89,5	11,7	
90,0																	90,5	11,9	
91,0																	91,5	12,0	
92,0																	92,5	12,0	
93,0																	93,5	12,3	
94,0																	94,5	12,4	
95,0																	95,5	12,5	
96,0																	96,5	12,7	
97,0																	97,5	12,8	
98,0																	98,5	12,9	
99,0																	99,5	13,1	
100,0																	100,5	13,2	

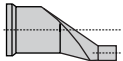

Standardgrößen Langloch- und rundexzentrische Stempel und Matrizen



																						Tm./mm		
	5/27	6	8/31	8/40	10/26	10/40	11	11A	12	12A	13	13A	5		6	8	10	11	12	13				
7 x 10														7,7 x 10,7										1,2
7 x 15														7,7 x 15,7										1,6
7 x 20														7,7 x 20,7										2,0
9 x 13														9,7 x 13,7										1,5
9 x 19														9,7 x 19,7										2,0
9 x 25														9,7 x 25,7										2,5
11 x 17														11,7 x 17,7										1,9
11 x 23														11,7 x 23,7										2,5
13 x 18														13,7 x 18,7										2,1
13 x 22														13,7 x 22,7										2,5
13 x 27														13,7 x 27,7										2,9
13 x 31														13,7 x 31,7										3,2
15 x 20														15,7 x 20,7										2,4
15 x 24														15,7 x 24,7										2,7
15 x 27														15,7 x 27,7										3,0
15 x 31														15,7 x 31,7										3,3
17 x 22														17,7 x 22,7										2,7
17 x 26														17,7 x 26,7										3,0
17 x 31														17,7 x 31,7										3,4
17 x 40														17,7 x 40,7										4,1
19 x 26														19,7 x 26,7										3,1
19 x 31														19,7 x 31,7										3,5
19 x 40														19,7 x 40,7										4,3
21 x 27														21,7 x 27,7										3,3
21 x 31														21,7 x 31,7										3,6
21 x 40														21,7 x 40,7										4,4
25 x 45														25,5 x 45,5										5,0
25 x 50														25,5 x 50,5										5,4
27 x 63														27,5 x 63,5										6,6
27 x 75														27,5 x 75,5										7,6
30 x 87														30,5 x 87,5										8,7
30 x 100														30,5 x 100,5										9,8

	TYP						TYP				Tm./mm
	5/27	6	8/31	8/40	10/40		5/27	6	8/31	10/40	
5						5,7					0,7
6						6,7					0,8
7						7,7					0,9
8						8,7					1,1
9						9,7					1,2
10						10,7					1,3
11						11,7					1,5
12						12,7					1,6
13						13,7					1,7
14						14,7					1,8
15						15,7					2,0
16						16,7					2,1
17						17,7					2,2
18						18,7					2,4
19						19,7					2,5
20						20,7					2,6
21						21,7					2,8
22						22,7					2,9
23						23,7					3,0
24						24,7					3,2
25						25,7					3,3

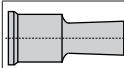
Materialstärke  e max. = $\frac{\varnothing}{2}$

Standardgrößen Quadrat- und Rechteckstempel und Matrizen

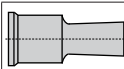
	TYP														TYP							Tm./mm														
	5/27	6	8/31	8/40	10/26	10/40	11	11A	12	12A	13	13A	5		6	8	10	11	12	13																
4																				4,7															0,7	
5																																				0,8
6																																				1,0
7																																				1,2
8																																				1,3
9																																				1,5
10																																				1,7
11																																				1,8
12																																				2,0
13																																				2,2
14																																				2,4
15																																				2,5
16																																				2,7
17																																				2,9
18																																				3,0
19																																				3,2
20																																				3,4
21																																				3,5
22																																				3,7
24																																				4,0
26																																				4,4
28																																				4,7
31																																				5,2
33																																				5,5
35																																				5,9
40																																				6,7
44																																				7,4
48																																				8,1
53																																				8,9
58																																				9,7
64																																				10,8
70																																				11,8

	TYP														TYP							Tm./mm														
	5/27	6	8/31	8/40	10/26	10/40	11	11A	12	12A	13	13A	5		6	8	10	11	12	13																
7 x 10																																				1,4
7 x 15																																				1,8
9 x 13																																				1,8
9 x 19																																				2,3
11 x 17																																				2,3
11 x 23																																				2,8
13 x 19																																				2,6
13 x 25																																				3,2
15 x 21																																				3,0
15 x 27																																				3,5
17 x 25																																				3,5
19 x 30																																				4,1
20 x 34																																				4,5
25 x 43																																				5,7
25 x 70																																				8,0
25 x 96																																				10,2

MEHR ALS 3.000 WERKZEUGE STÄNDIG AB LAGER VERFÜGBAR



Unsere Werkzeuge
passen auch auf
andere Fabrikate wie
Peddinghaus, Mubea etc.
Wir beraten Sie
gerne!

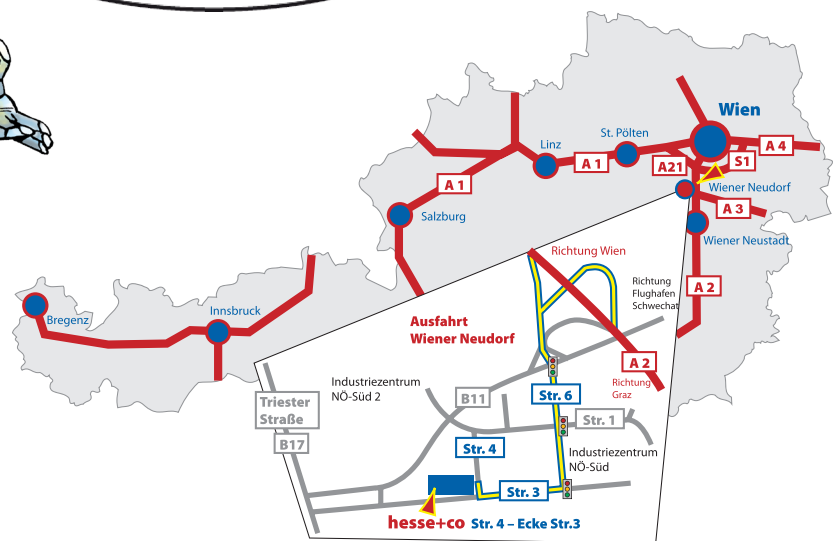
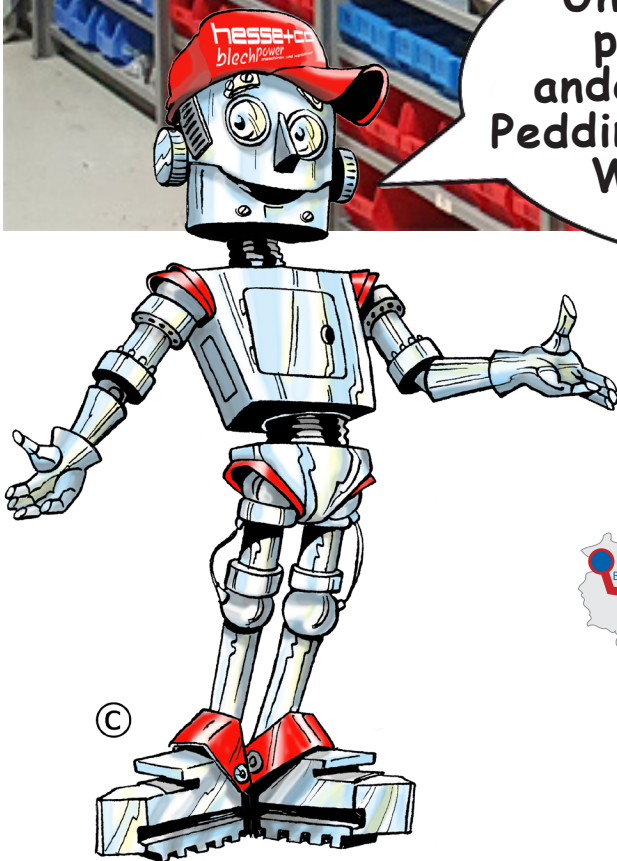

HESSE+CO Maschinenfabrik GmbH
 Industriezentrum NÖ-Süd
 Straße 4 - Objekt 8
 A-2351 Wiener Neudorf
 AUSTRIA

hesse **hesse+co**
blechpower
 maschinen und werkzeuge

Technische Änderungen, Irrtum und Druckfehler vorbehalten.
 Gültig bis auf Widerruf.

Tel.: +43/2236/638 70-0
 Fax: +43/2236/636 62
 office@hesse-maschinen.com
 www.hesse-maschinen.com
 www.blechpower.com