

AD-ES

Series

Electrical Press Brakes



Perfect Precision

High Capacity

Low Energy Consumption

Elegant Design



As a total supplier for sheet metal manufacturing with almost 70 years of experience, Durma understands and recognizes the challenges, requirements and expectations of the industry. We strive to satisfy the ever higher demands of our customers by continuously improving our products and processes while researching and implementing the latest technologies

In our three production plants with a total of 150.000 m², we dedicate 1,000 employees to delivering high quality manufacturing solutions at the best performance-to-price ratio in the market.



PRODUCTION IS
MORE EFFECTIVE NOW

From the innovations developed at our Research & Development Center to the technical support given by our worldwide distributors, we all have one common mission: to be your preferred partner.

Durmazlar offers it's machines to the world markets under the Durma brand.



1

High technology,
modern production
lines



2

Top quality
components

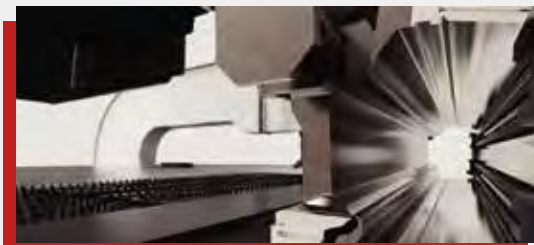

3

High quality
machines designed
in R&D Centre

AD-ES

AD-ES Series Electrical Press Brake **Environment Friendly**

DURMA AD-ES CNC PRESS BRAKE serial can provide the production starting from 1250 mm table width to 2050 mm table width. It is also possible to apply different sizes in line with customer demands.

Welding is performed on the machine body and upper table and all waste is prevented by stress relieving and appropriate processing technologies. Reducer drive system, precision ball screw, and nut connection, high torque-resistant bearing cylinder provide high precision bending results.



ENVIRONMENT FRIENDLY LOW COST HIGH GAIN

- Precise bending result
- Minimalized tool change and adjustment time
- Maximized speed and safety

Energy-efficient Hydraulics with Variable Speed Pump Drives

Energy consumption has a significant effect on Total Cost of Ownership of plant and machinery: Even with standard machines, the energy consumption represents 30% of total costs, and with particularly energy-intensive applications, this share is remarkably higher.

High Capacity > Robust Body > Perfect Precision > Winning > Ergonomic

Advantages

- High energy saving
- Decrease in operating costs
- Easy cooling
- Operational reliability
- High availability
- Low investment cost
- System reliability
- Compliance with current technology
- Significant decrease in noise level
- Less measurement needing
- Ease of integration of control functions
- Low maintenance cost
- Compliance with European Union standards

Low Power
Consumption

AD-ES

ENERGY CONSUMPTION COMPARISONS OF PRESS BRAKES

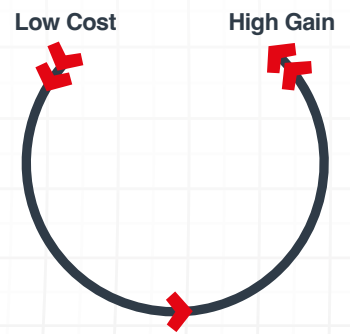
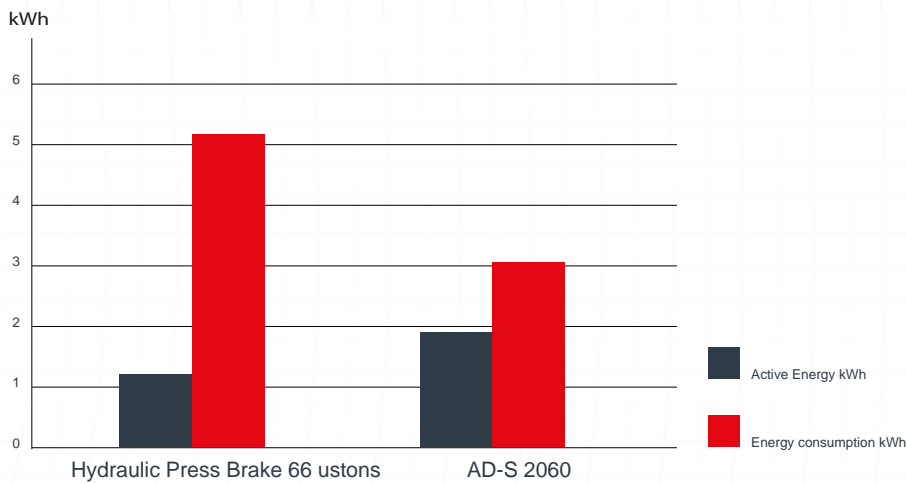

Main Components

- Servo-motor
- Reducer
- Ball screw and nut
- Mechanical Roller Bearing
- Software

Physical Features

- Position Control
- Press/Load Press Control

Efficiency

- 40% Less energy consumption
- 17% more productivity

Technical Data	AD-ES 2040	AD-S 2060
Motor power	7.2 kW	7.5 kW
Power consumption	3.1 kWh	5.2 kWh
Oil Capacity	-	100 lt
Approach Speed (mm/min.)	115	200
Bending Speed (mm/min.)	10-20	10
Return Speed (mm/min.)	115	110

Production is *More Effective Now.*

High Increase in Production Efficiency

Our AD-ES series solutions provide high energy savings to our business with speed, efficiency, quality and low power consumption.



- Energy saving
- Same consistency in each cycle
- Economic
- Repeatability at high speed



AD-ES

FAST, EFFICIENT, MODERN

AD-ES Series press brakes, designed with high technology to increase efficiency on precise part bending. Quality approved components used. Stress relieved made on bodies for long life and precise bending.

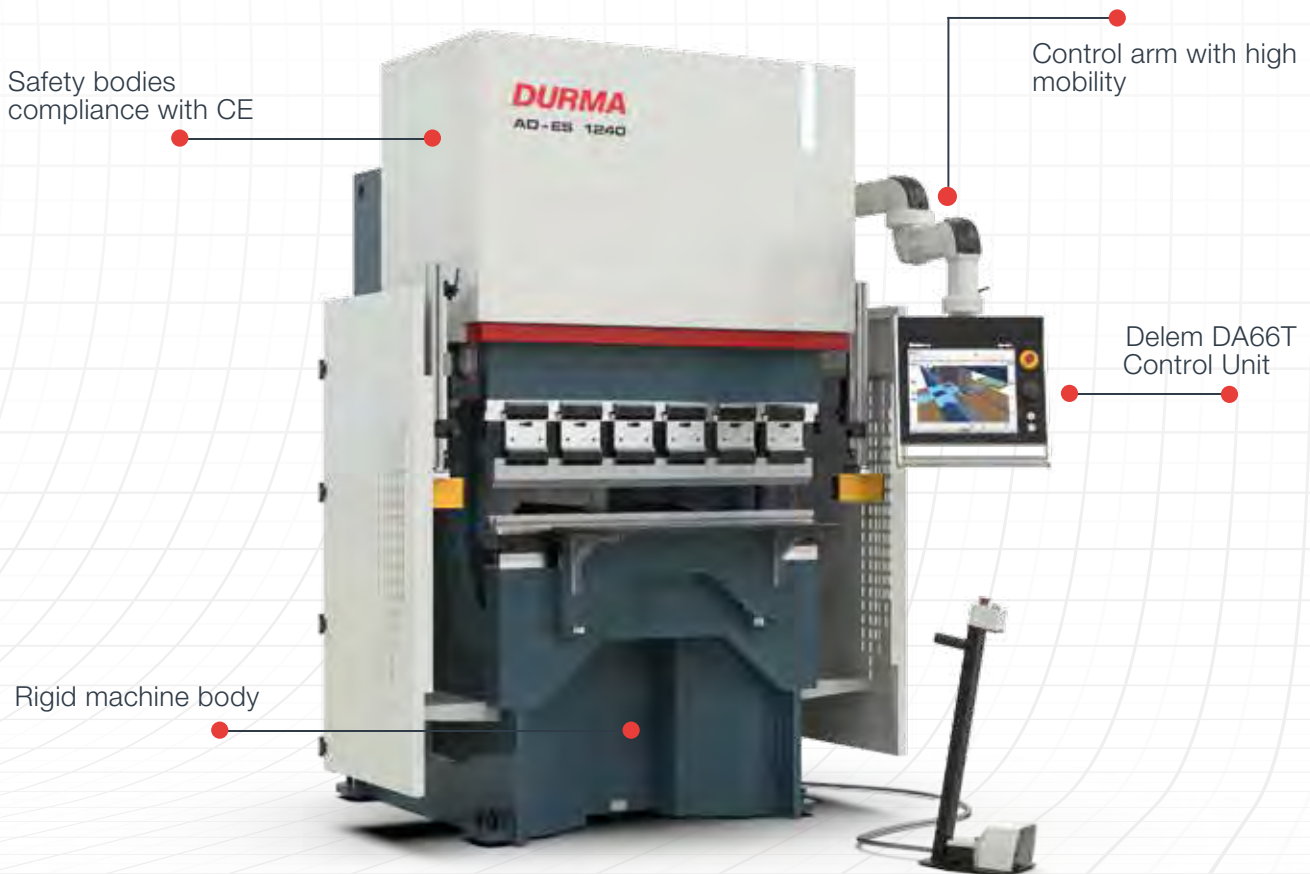

General Specifications

- Precision reducer system
- Upper table suitable for world standard tools
- Robust body structure with long life and high performance
- Electric panels creating a safer working environment
- Servo motors providing high speed and high precision
- Ball screw and nut connection providing excellent power and motion transmission
- Back support system with rigid aluminum body
- AP1-AP2 system with high mobility and aluminum miter
- CE norm safety standards

STRONG BACK GAUGE SYSTEM

■ **Precise**

■ **Reliable**

■ **Strong**

- Fast and high accuracy
- Safe movement
- Long-life linear motion elements
- No maintenance required
- Simple to use, easy to maintain

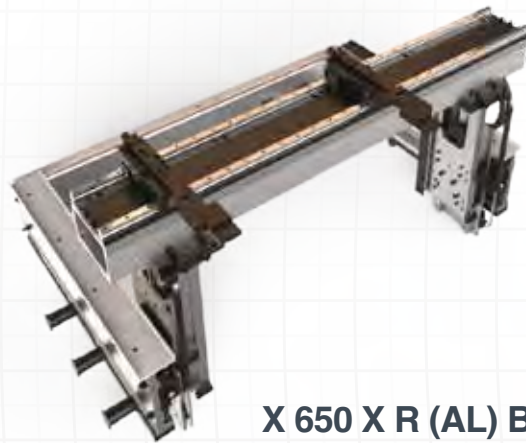

X 650 X R (AL) Back Gauge

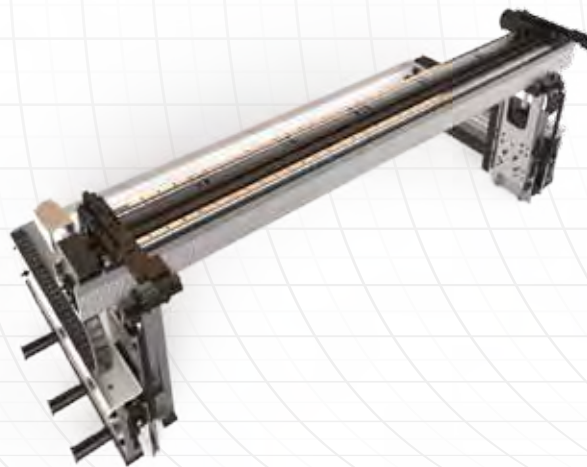

X 650 X R Z1 Z2 (AL) Back Gauge

Why DURMA Back Gauge ?

The most important feature to achieve perfect bending is the stability and the design of the back gauge, which allows an impeccable and correct product to be produced.

The high speed **double ballscrew** back gauge system movement is also supported with **double linear guides**, which helps the back gauge achieve long life, greater sensitivity and strengthens against any collisions.

Special designed finger blocks with steps to achieve maximum stability can also be supplied for every kind of bending solution.

- AD-ES back gauge systems are long-life, precise and strength against collisions.
- High speed back gauge system moving with ballscrew is also supported with linear guides.

TOOL HOLDERS AND TOOLS

The bending performance of the machine is increased by using High Quality European type clamping system and ease of use is provided. The lower body is designed as narrow for Z type bending and designed in accordance with European type tool holding system.

DURMA is your solution partner with various tool options.

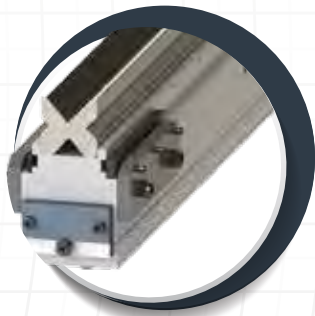

European Type
Bottom Tool (4V Die)



DURMA Multi
V Bottom Tool

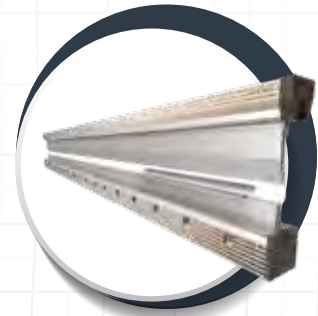

DURMA Hydraulic
Holder



European
Clamping System

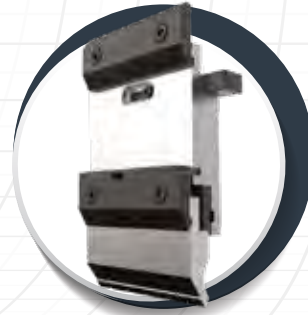

Quick
Release Clamping

SAFE AND ACCURATE BENDS WITH TOP QUALITY EQUIPMENTS

■ Crowning System

CNC controlled, motorized crowning system provides perfect result in each point of bending. Your bending differences arising from the material or other factors are calculated by motorized CNC crowning system and the perfect result is achieved.



Motorized Crowning System

■ CE Safety Systems

Our machines are designed in accordance with European CE standards and directives in order to ensure your safety with hydraulic, electric, appropriate height covers and laser light curtains. CE safety in tandem machines are provided with light barriers.



CE Laser Safety Systems

■ Aluminum Sheet Support System

Strong front arm can be moved to the right and left and fixed at the desired position with linear slide and roller system. With aluminum miter and bar support, the sheet material can be easily moved to the machine.



Front Sheet Support System with Linear Slide, Aluminum Miter

NOW BENDING IS MORE EASY

■ Delem - 66T (Standard)



- 2D Graphic touch screen and programming mode
- 3D imaging in simulation and production
- 17" High resolution colors
- Suitable for full Windows applications compatible with DelemModusys
- USB and peripheral interface
- User specific application support Multitasking competencies
- Sensor bending and correction interface

■ Delem-69S (Optional)



- 24" TFT screen, 1920 x3080 pixels, 32 bit colour,
- Real-time Linux embedded OS
- Full touch screen control
- Storage capacity 4 GB
- Network connectivity
- Delem modusys compatible
- Tandem operation
- 2D/3D real-scale product programming and visualisation
- Automatic bending calculation 2D/3D
- DXF part & tool import support

*Production is **More Effective Now.***

■ **DURMA Angle Measuring**



■ **Operator table support system**



■ **Robotic Solutions**



ADVANTAGES COMPARED TO CLASSICAL PRESS BRAKES

Drive System Group Equipment

- Servo Motor
- Gearbox
- Mechanical Roller Bearing
- Ballscrew and Nut

Equipment Advantages

- Simpler Drive Group
- Less Component
- Easy and Fast Assembly
- Easy and quick maintenance
- Hydraulic oil-free drive system



■ Standard Hydraulic Press Brake

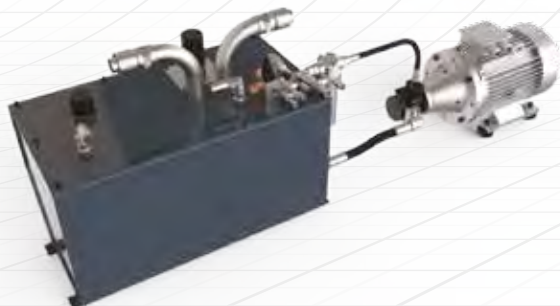

■ Servo Hydraulic Press Brake

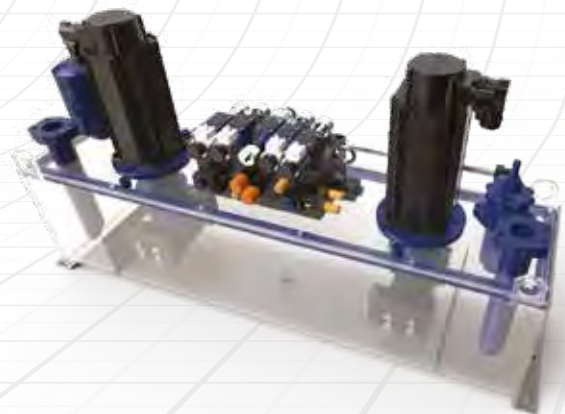

AD-ES SERIES TECHNICAL DETAILS

Machine Types	Bending Force	Bending Length (B)	Distance Between Columns(A)	Stroke	Daylight (C)	Throat Depth	Working Height	Rapid Speed	Bending Speed	Return Speed	Back Gauge X Axis Length	Back Gauge R Axis Length	Length (L)	Width (W)	Height (H)	Weight
Unit	Ton	mm	mm	mm	mm	mm	mm	mm/sec.	mm/sec.	mm/sec.	mm	mm	mm	mm	mm	kg
AD-ES 1240	40	1250	1050	200	440	250	1000	115	10-20*	115	650	250	2150	1625	2800	3.900
AD-ES 2040	40	2050	1700	200	440	350	1000	115	10-20*	115	650	250	2870	1625	2800	4.400

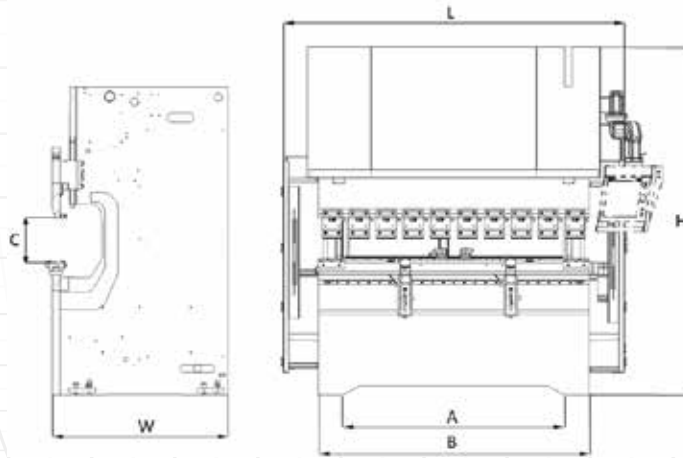

ROBOTCELL TECHNICAL DETAILS

Air Pressure	5 - 7 bar
Voltage	380 - 480 V
Power Supply	1.5 kW
Robot Maximum Lifting Force	12 Kg
R-Cell Length	1250 mm
R-Cell Width	1950 mm
R-Cell Height	2150 mm
R-Cell Weight	1100 kg

PRODUCTION IS MORE EFFECTIVE NOW

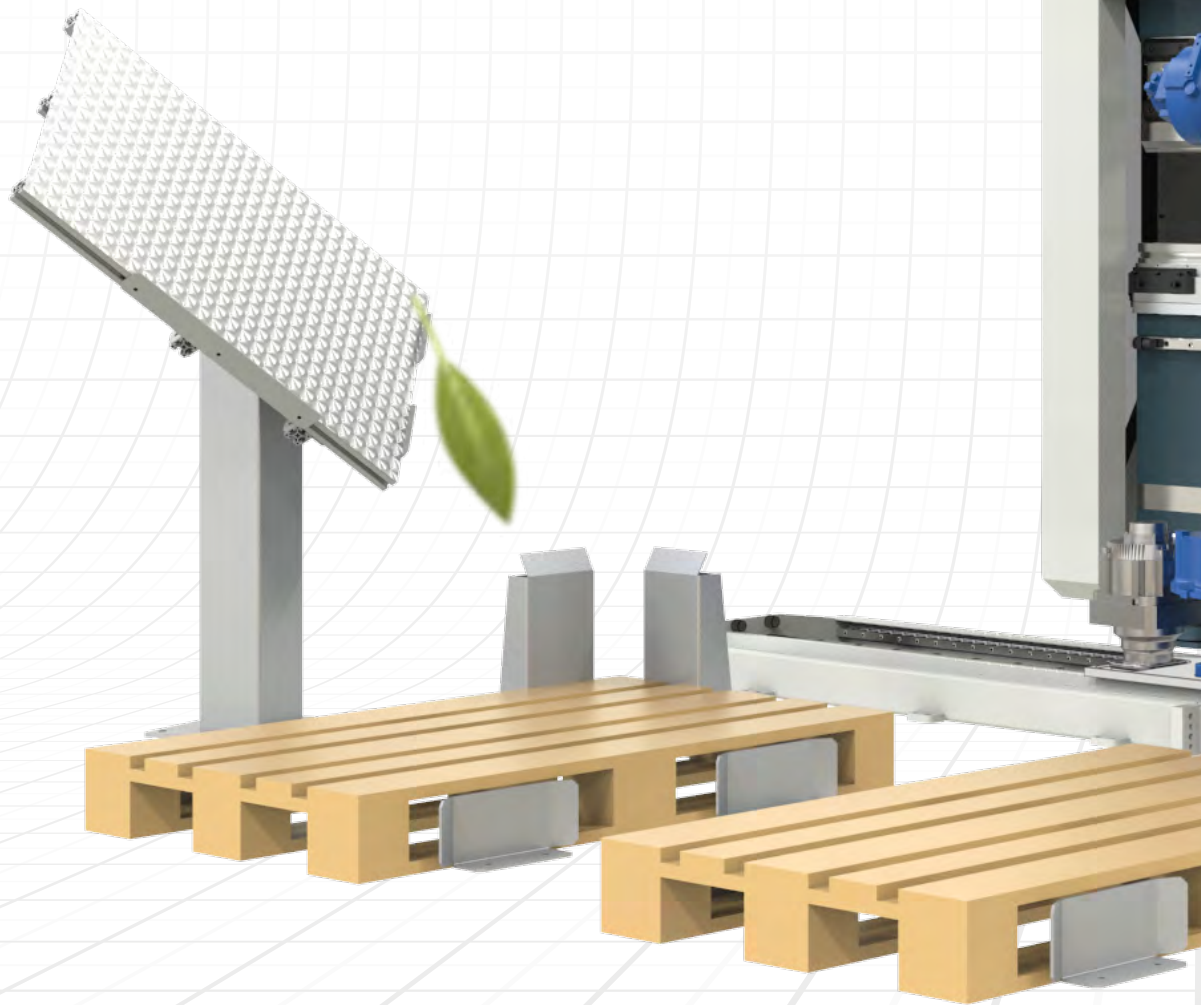



STANDARD & OPTIONAL EQUIPMENT

Standard Equipment

Control Unit - DA 66T

Y1, Y2, X, R - 4- Axis

F. AKAS LC 5 front safety system

Servo motor back gauge & linear guided & ballscrew system (X-R)

CNC controlled motorized crowning (2040)

European style tool clamping system

Sliding front arms (With T-Slot and stopper)

World standard electric equipment

Optional Equipment

Control Unit - DA 69S

X=650 mm X,R,Z1,Z2 Delta X Axis \pm 125 stroke

Motorized X,R,Z1,Z2 Axes backgauge

Durma laser angle measurement

DBEND 3D bending simulation program

Quick release clamping system

Hydraulic and pneumatic tool clamping systems

Additional back gauge finger and sliding front support arms

Special packing for overseas shipments

Production is *More Effective Now.*

FAST ON SERVICE AND SPARE PARTS

DURMA provides the best level of service and spare parts with qualified personnel and spare parts in stock. Our experienced and professional service personnel are always ready at your service. Our professional training and application enriched courses will give you an advantage to use our machinery.



Vertrauen Sie auf über 70 Jahre Erfahrung!

Die Firma HESSE+CO wurde 1947 als Hersteller von Blechbearbeitungsmaschinen gegründet. Seit 1980 sind wir auf den Handel mit neuen sowie gebrauchten Blechbearbeitungs- und Werkzeugmaschinen spezialisiert. Wir haben ständig etwa 300 Maschinen in unserer 2.000 m² großen Ausstellungshalle, die nur 20 Minuten vom internationalen Flughafen Wien entfernt ist.

Trust in more than 70 years of experience!

HESSE+CO was established in 1947 as a manufacturer of sheet metal working machines. Since 1980 we are specialized in dealing with new and second hand sheet metal processing machines and machine tools. We always have approximately 300 machines available in our 2.000 m² showroom, which is located only 20 minutes from the Vienna International Airport, waiting for your inspection.

www.hesse-maschinen.com

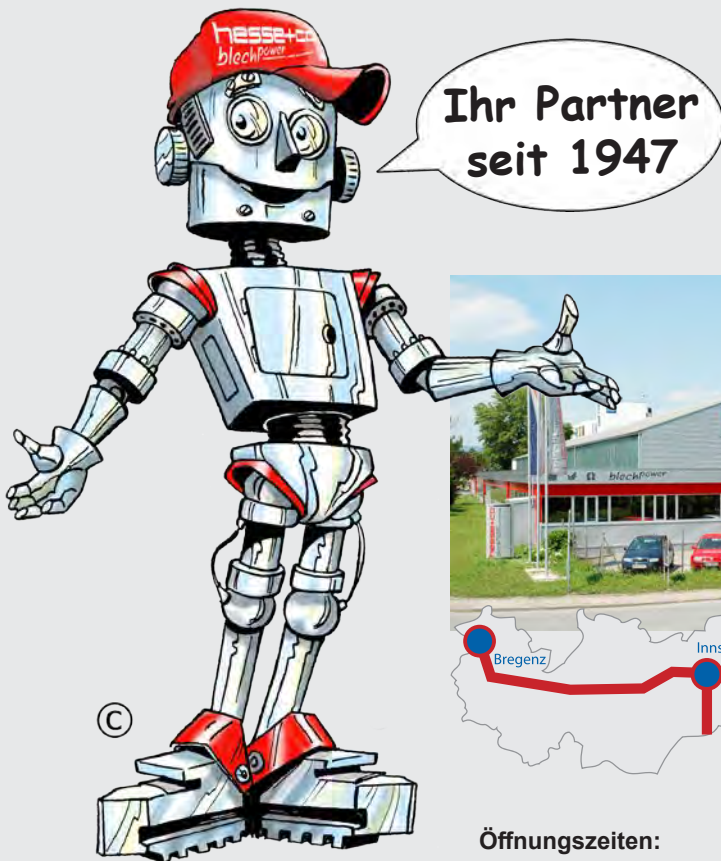

Öffnungszeiten:

Mo - Do 8:00 - 16:30 Uhr
Fr 8:00 - 14:30 Uhr

HESSE+CO Maschinenfabrik GmbH
Industrienzentrum NÖ-Süd
Straße 4 - Objekt 8
A-2351 Wiener Neudorf
AUSTRIA

hesse **hesse+co**
blechpower
maschinen und werkzeuge

Technische Änderungen, Irrtum und Druckfehler vorbehalten.
Gültig bis auf Widerruf.

Tel.: +43/2236/638 70-0
Fax: +43/2236/636 62
office@hesse-maschinen.com
www.hesse-maschinen.com
www.blechpower.com